

AXIS P14 Network Camera Series

AXIS P1405-LE Mk II Network Camera

AXIS P1425-LE Mk II Network Camera

AXIS P1435-LE Network Camera

AXIS P14 Network Camera Series

Table of Contents

About this manual	3
System overview	4
Product overview	5
How to access the product	7
How to access the product from a browser	7
About secure passwords	7
Setup	9
About the product's built-in help	9
Image quality	9
Overlays	15
Streaming and storage	15
Events	16
Applications	18
Troubleshooting	19
How to reset to factory default settings	19
How to check the current firmware	19
How to upgrade the firmware	19
Technical issues, clues and solutions	20
Performance considerations	21
Specifications	22
LED Indicators	22
SD card slot	22
Buttons	22
Connectors	22
Connection Diagrams	23

AXIS P14 Network Camera Series

About this manual

About this manual

This User Manual provides information on the product regarding:

- Access
- Main use cases
- Troubleshooting
- Specifications

Note

The User Manual may include more than one product. Part of the content, e.g. some use cases or specifications, may only apply to some of them. For more information on the exact feature set and specifications, see the product's web page and datasheet at www.axis.com

AXIS P14 Network Camera Series

System overview

System overview

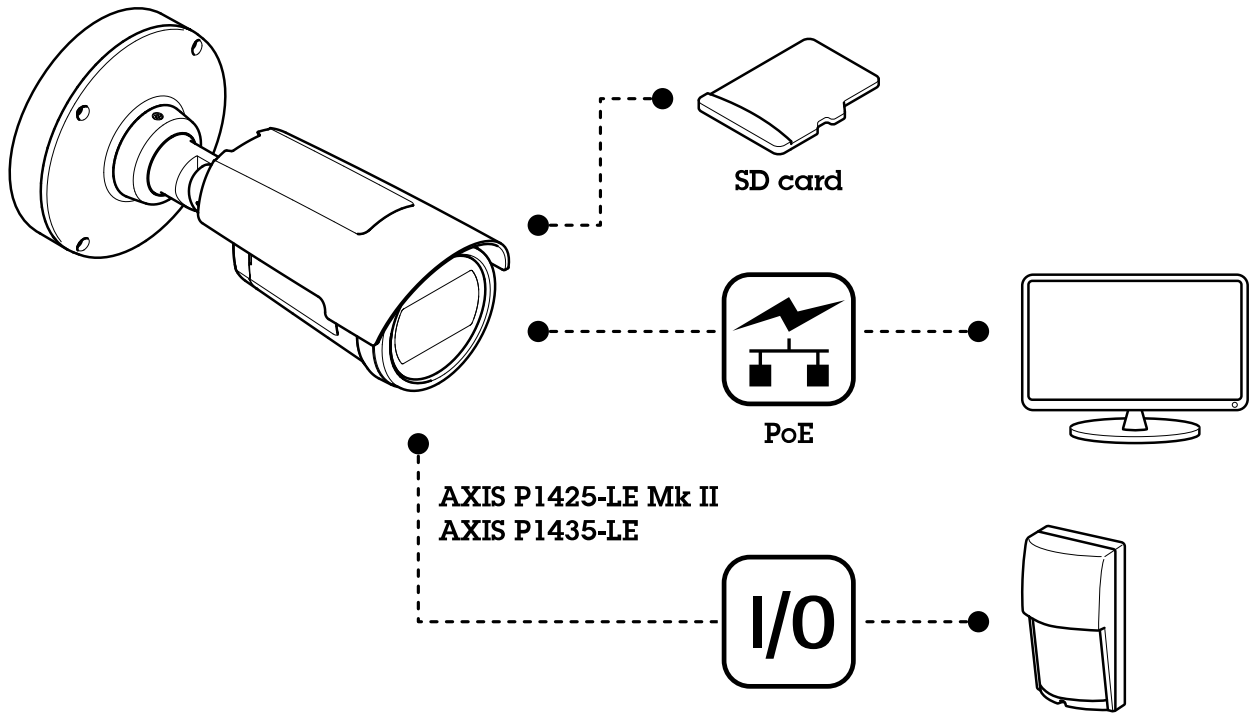

AXIS P14 Network Camera Series

Product overview

Product overview

AXIS P1405-LE Mk II Network Camera

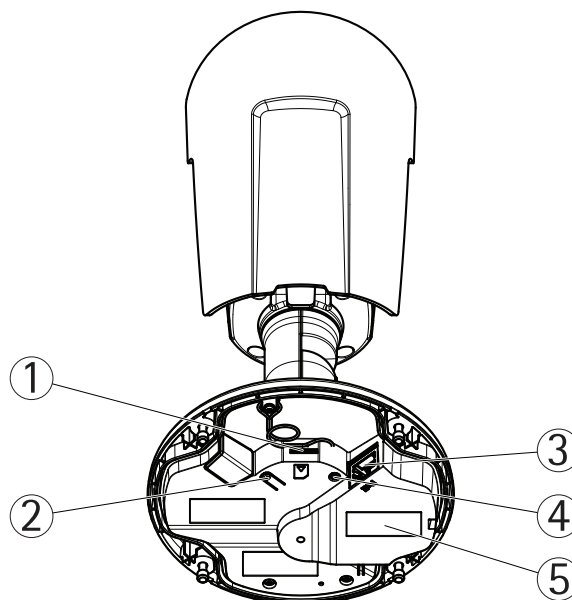

- 1 *microSD card slot*
- 2 *Control button*
- 3 *Network connector*
- 4 *Status LED indicator*
- 5 *Part number (P/N) & Serial number (S/N)*

AXIS P1425-LE Mk II and AXIS P1435-LE Network Cameras

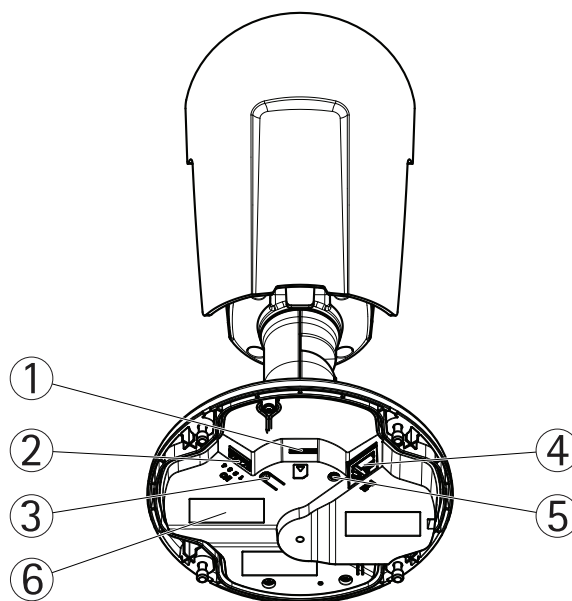

- 1 *microSD card slot*

AXIS P14 Network Camera Series

Product overview

- 2 *I/O connector*
- 3 *Control button*
- 4 *Network connector*
- 5 *Status LED indicator*
- 6 *Part number (P/N) & Serial number (S/N)*

AXIS P14 Network Camera Series

How to access the product

How to access the product

AXIS IP Utility and AXIS Camera Management are recommended methods for finding Axis products on the network and assigning them IP addresses in Windows®. Both applications are free and can be downloaded from axis.com/support

The product can be used with the following browsers:

- Chrome™ (recommended), Firefox®, Edge®, or Opera® with Windows®
- Chrome™ (recommended) or Safari® with OS X®
- Chrome™ or Firefox® with other operating systems.

How to access the product from a browser

1. Start a web browser.
2. Enter the IP address or host name of the Axis product in the browser's address field.

To access the product from a Mac computer (OS X), go to Safari, click on Bonjour and select the product from the drop-down list.

If you do not know the IP address, use AXIS IP Utility to locate the product on the network. For information about how to discover and assign an IP address, see the document *Assign an IP Address and Access the Video Stream* on Axis Support web at axis.com/support

Note

To show Bonjour as a browser bookmark, go to **Safari > Preferences**.

3. Enter your username and password. If this is the first time the product is accessed, the root password must first be configured.
4. The product's live view page opens in your browser.

About secure passwords

Important

When setting the initial password, the password is sent in clear text over the network. If there is a risk of network sniffing, first set up a secure and encrypted HTTPS connection before resetting the passwords.

The device password is the primary protection for the data and services. Axis' products do not impose a password policy as products may be used in various types of installations, but to protect your data do the following:

- Don't use the default password that comes with the products.
- Use a password with at least 8 characters, preferably using a password generator.
- Don't expose the password.
- Change password at a recurring interval, at least once a year.

Set a password for the root account

Important

The default administrator user name **root** is permanent and cannot be deleted. If the password for root is lost, the product must be reset to the factory default settings.

AXIS P14 Network Camera Series

How to access the product

The default root account has full privileges and should be reserved for administrative tasks. Always create a user account with limited privileges for daily use. This reduces the exposure of the administrative account.

1. Make sure to follow the instructions about secure passwords, see *About secure passwords on page 7*.
2. Type a password and then retype it to confirm the spelling.
3. Click **Create login**. The password has now been configured.

AXIS P14 Network Camera Series

Setup

Setup

About the product's built-in help

You can access the built-in help through your product's web page. The help provides more detailed information on the product's features and their settings.

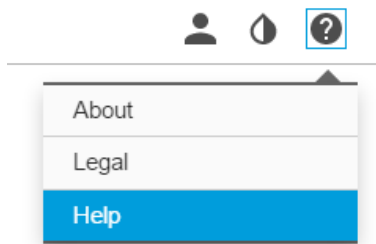
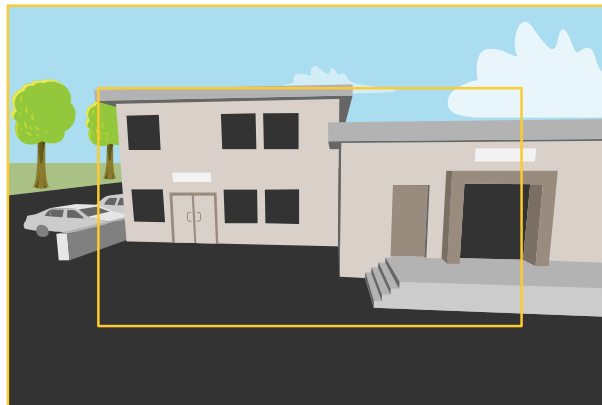

Image quality

About capture modes

Capture mode defines the maximum resolution and maximum frame rate available in the Axis product. If using a capture mode with a smaller resolution than the maximum resolution, the angle of view is reduced. The capture mode also affects light sensitivity. A capture mode with a high maximum frame rate has reduced light sensitivity and vice versa.

The lower resolution capture mode is cropped out from the highest resolution.



The image shows how the field of view and aspect ratio can change between two different capture modes.

How to select capture mode

What capture mode to choose depends on the requirements of frame rate and resolution for the specific surveillance setup. For specifications about available capture modes, see the product's datasheet. To find the latest version of the datasheet, go to axis.com

How to select exposure mode

There are several exposure mode options in the camera that adjusts aperture, shutter speed, and gain to improve image quality for specific surveillance scenes. In the **Image** tab, select between the following options:

AXIS P14 Network Camera Series

Setup

- For most use cases, select **Automatic** exposure.
- For environments with certain artificial lighting, for example fluorescent lighting, select **Flicker-free**.
- For environments with certain artificial light and bright light, for example outdoors with fluorescent lighting at night and sun during daytime, select **Flicker-reduced**.
- To lock the current exposure settings, select **Hold current**.

About view area

A view area is a cropped part of the full view. You can stream and store view areas instead of the full view to minimize bandwidth and storage needs. If you enable PTZ for a view area, you can pan, tilt and zoom within it. By using view areas you can remove parts of the full view, for example sky.

When you set up a view area, we recommend you to set the video stream resolution to the same size as or smaller than the view area size. If you set the video stream resolution larger than the view area size it implies digitally scaled up video after sensor capture, which requires more bandwidth without adding image information.

How to hide parts of the image with privacy masks

If you want to hide parts of the image due to privacy reasons, use one or several privacy masks.

What is a privacy mask?

A privacy mask is a user-defined area that covers parts of the monitored area. Privacy masks appear as blocks of solid color and are applied on the video stream.

Privacy masks can not be bypassed through the VAPIX® application programming interface (API).

Important

If you add many privacy masks, this may affect the product's performance.

How to create a privacy mask

To create or edit a privacy mask, go to **Settings > Privacy mask**.

How to focus

1. Go to **Settings > Image > Focus**.
2. Click **Autofocus**.

About remote focus and zoom

The remote focus and zoom functionality allows you to make focus and zoom adjustments to your camera from a computer. It is a convenient way to ensure that the scene's focus, viewing angle and resolution are optimized without having to visit the camera's installation location.

AXIS P14 Network Camera Series

Setup



Left: no focus. Right: remote focus applied.



Left: no zoom. Right: remote zoom applied.

How to enhance facial recognition

To better recognize the face of a person passing by the camera, you can set the optimal pixel resolution with the camera's pixel counter.

AXIS P14 Network Camera Series

Setup

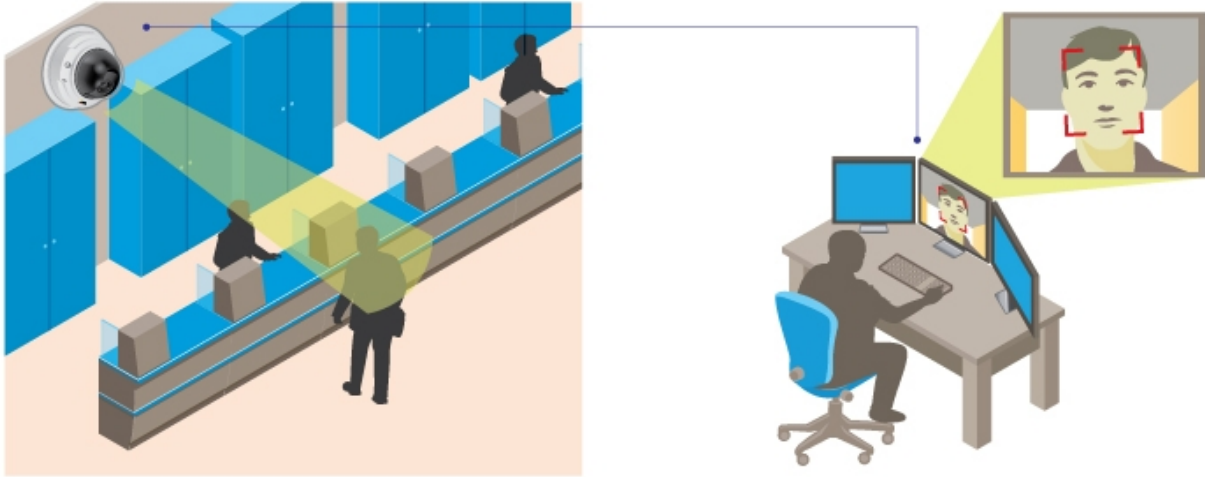

1. Go to **Settings > System > Orientation** and click .
2. Adjust the size and placement of the rectangle in the camera's live view around the area of interest, for example where the faces of passing persons are expected to appear. You can then see the number of pixels represented by the sides of the rectangle.

Note

You can use an object of a known size in the view as a reference to decide how much resolution is needed for recognition.

How to enhance license plate recognition

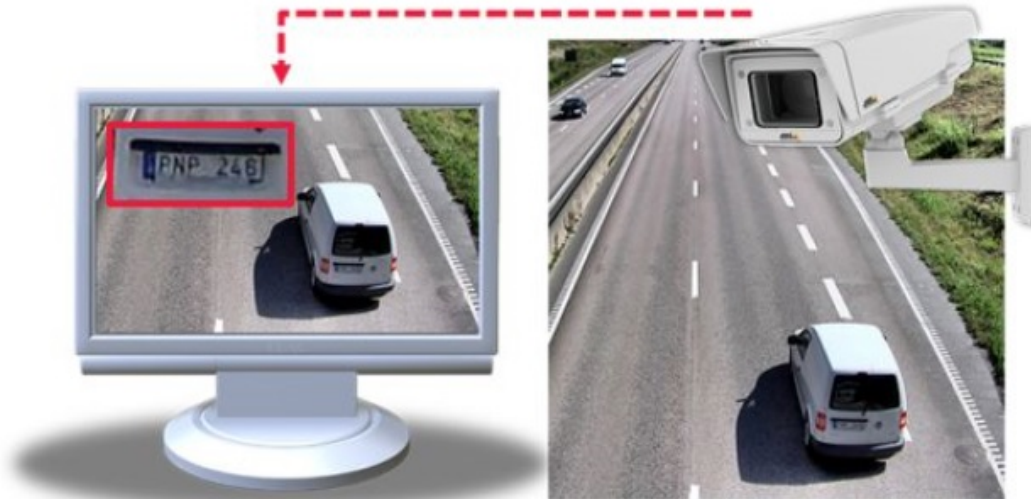

To better recognize the license plate of a car passing by the camera, you can apply and adjust a number of things.

One option is to use the pixel counter in your camera to set the optimal pixel resolution:

1. Go to **Settings > System > Orientation** and click .

AXIS P14 Network Camera Series

Setup

2. Adjust the size and placement of the rectangle in the camera's live view around the area of interest, for example where the license plates of passing cars are expected to appear. You can then see the number of pixels represented by the sides of the rectangle.

Note

You can use an object of a known size in the view as a reference to decide how much resolution is needed for recognition.

In addition, you can try to adjust the following to optimize license plate recognition:

- Shutter speed
- Gain
- Zoom

How to monitor long and narrow areas

Use corridor format to better utilize the full field of view in a long and narrow area, for example a staircase, hallway, road, or tunnel.

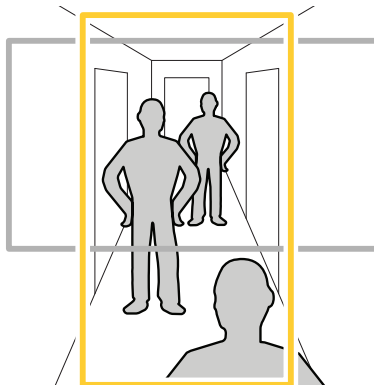

1. Depending on your product, turn the camera or the 3-axis lens in the camera 90° or 270°.
2. Go to **Settings > Stream > Orientation** on the product's webpage and rotate the view 90° or 270°.

Find out more at axis.com/axis-corridor-format

How to reduce noise in low-light conditions

To reduce noise in low-light conditions, you can adjust one or more of the following settings:

- Make sure that the exposure mode is automatic.

Note

Increasing the max shutter value can result in motion blur.

- The shutter speed should be as slow as possible, which means you should set max shutter to the highest possible value.
- Reduce sharpness in the image.
- Try lowering the max gain value.

How to handle scenes with strong backlight

Use WDR to make both dark and bright areas of the image visible.

1. Go to **Settings > Image**.

AXIS P14 Network Camera Series

Setup

2. Turn on WDR under Wide dynamic range.



Image without WDR.



Image with WDR.

Note

If you use WDR, you may experience some WDR artifacts in the image.

Find out more about WDR and how to use it at axis.com/web-articles/wdr

How to benefit from IR light in low-light conditions using night mode

Your camera delivers color images during the day. As light diminishes, you can set the camera to automatically shift to night mode. This enables delivering black-and-white images with the help of IR light.

1. Go to **Settings > Image > Day and night**, and make sure that the **IR cut filter** is set to **Auto**.
2. To determine at what light level you want the camera to shift to night mode, move the **Threshold** slider toward **Bright** or **Dark**.

Note

If you set the shift to occur when it's brighter, the image remains sharper as there will be less low-light noise. If you set the shift to occur when it's darker, the image colors are maintained longer but there will be more image blur due to low-light noise.

3. Enable IR illumination to use the camera's built-in IR light when the night mode is activated.

How to maximize details in an image

Important

If you maximize details in an image, bitrate increases and might lead to reduced frame rate.

AXIS P14 Network Camera Series

Setup

- Make sure to select capture mode that has the highest resolution.
- Set compression as low as possible.
- Select MJPEG streaming.
- Turn off the Zipstream functionality.

Overlays

About overlays

Overlays are superimposed over the video stream. They are used to provide extra information during recordings, such as a timestamp, or during product installation and configuration.

How to show a text overlay when the camera detects motion

This example explains how to display the text "Motion detected" when the camera detects motion:

1. Go to **Settings > Overlay**.
2. Enter #D in the text field.
3. Choose alignment, text size and appearance.
4. Include the text overlay.
5. Go to **System > Events > Action rules**.
6. Create an action rule with **AXIS Video Motion Detection** as trigger.
7. From the list of actions, select **Overlay text**.
8. Type "Motion detected".
9. Set the duration.

Streaming and storage

How to choose video compression format

Deciding which compression method to choose depends on your viewing requirements, and on the properties of your network. The available options are:

Motion JPEG

Motion JPEG or MJPEG is a digital video sequence that is made up of a series of individual JPEG images. These images are then displayed and updated at a rate sufficient to create a stream that shows constantly updated motion. For the viewer to perceive motion video the rate must be at least 16 image frames per second. Full motion video is perceived at 30 (NTSC) or 25 (PAL) frames per second.

The Motion JPEG stream uses considerable amounts of bandwidth, but provides excellent image quality and access to every image contained in the stream.

H.264 or MPEG-4 Part 10/AVC

Note

H.264 is a licensed technology. The Axis product includes one H.264 viewing client license. Installing additional unlicensed copies of the client is prohibited. To purchase additional licenses, contact your Axis reseller.

AXIS P14 Network Camera Series

Setup

H.264 can, without compromising image quality, reduce the size of a digital video file by more than 80% compared to the Motion JPEG format and by as much as 50% compared to the MPEG-4 standard. This means that less network bandwidth and storage space are required for a video file. Or seen another way, higher video quality can be achieved for a given bitrate.

Find out more at axis.com/compression-formats

How to reduce bandwidth and storage

Important

If you reduce the bandwidth it can result in less details in the picture.

1. Go to live view and select H.264.
2. Go to the **Stream** tab.
3. Do one or more of the following:
 - Turn on the Zipstream functionality and select the desired level.
 - Turn on the GOP and set a high GOP length value.
 - Increase the compression.
 - Turn on the dynamic FPS.

How to set up network storage

To store recordings on the network, you need to set up network storage:

1. Go to **Settings > System > Storage**.
2. Click **Setup** under **Network storage**.
3. Enter the IP address of the host server.
4. Enter the name of the shared location on the host server.
5. Move the switch if the share requires a login, and enter username and password.
6. Click **Connect**.

Events

About events

The event pages allow you to configure your product to perform actions when different events occur. For example, the product can start a recording or send an email notification when motion is detected. The set of conditions that defines how and when the action is triggered is called an action rule.

How to trigger an action

1. Go to **Settings > System > Events** to set up an action rule. The action rule defines when the product will perform certain actions. Action rules can be setup as scheduled, recurring, or for example, triggered by motion detection.
2. Select what **Trigger** must be met to trigger the action. If you specify more than one trigger for the action rule, all of them must be met to trigger the action.
3. Select which **Action** the camera should perform when the conditions are met.

Note

If you make changes to an active action rule, the action rule needs to be restarted for the changes to take effect.

AXIS P14 Network Camera Series

Setup

How to record video when the camera detects motion

This example explains how to set up the camera to start recording to the SD card five seconds before it detects motion and to stop one minute after.

Make sure the AXIS Video Motion Detection application is running:

1. Go to **Settings > Apps > AXIS Video Motion Detection**.
2. Start the application if it is not already running.
3. Make sure you have set up the application according to your needs.

Create an action rule:

4. Go to **Settings > System > Events** and add an action rule.
5. Type a name for the action rule.
6. From the list of triggers, select **Applications** and then select **AXIS Video Motion Detection (VMD)**.
7. From the list of actions, select **Record video**.
8. Select an existing stream profile or create a new one.
9. Set the pre-trigger time to 5 seconds.
10. Set the post-trigger time to 60 seconds.
11. Select **SD card** from the list of storage options.
12. Click **Ok**.

How to record video when a PIR detector senses motion

This example explains how to connect an Axis PIR detector to the camera, and set up the camera to start recording when the detector senses motion.

Required hardware

- 3-wire cable (ground, power, I/O)
- Axis PIR detector

NOTICE

Disconnect the camera from power before connecting the wires. Reconnect to power after all connections are done.

Connect the wires to the camera's I/O connector

Note

For information on the I/O connector, see *Connectors* on page 22

1. Connect the ground wire to pin 1 (GND/-).
2. Connect the power wire to pin 2 (12V DC output).
3. Connect the I/O wire to pin 3 (I/O input).

Connect the wires to the PIR detector's I/O connector

AXIS P14 Network Camera Series

Setup

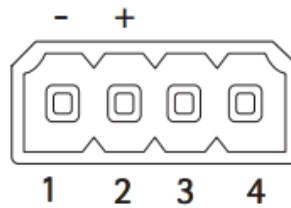

1. Connect the other end of the ground wire to pin 1 (GND/-).
2. Connect the other end of the power wire to pin 2 (DC input/+).
3. Connect the other end of the I/O wire to pin 3 (I/O output).

Configure the I/O port in the camera's web page

1. Go to **Settings > System > I/O ports**.
2. Give the input module a descriptive name.
3. To make the PIR detector send a signal to the camera when it senses motion, select **Closed circuit** in the drop-down list.

To trigger the camera to start recording when it receives a signal from the PIR detector, you need to create an action rule in the camera's web page.

Applications

About applications

AXIS Camera Application Platform (ACAP) is an open platform that enables third parties to develop analytics and other applications for Axis products. To find out more about available applications, downloads, trials and licenses, go to axis.com/applications

To find the user manuals for Axis applications, go to axis.com

Note

- Several applications can run at the same time but some applications might not be compatible with each other. Certain combinations of applications might require too much processing power or memory resources when run in parallel. Verify that the applications work together before deployment.

AXIS People Counter

AXIS People Counter is an analytic application that can be installed on a network camera.

The counter is embedded in the camera which means you do not need a dedicated computer to run the application. AXIS People Counter is intended for retail environments, like stores or shopping malls, or other environments where you want to count people.

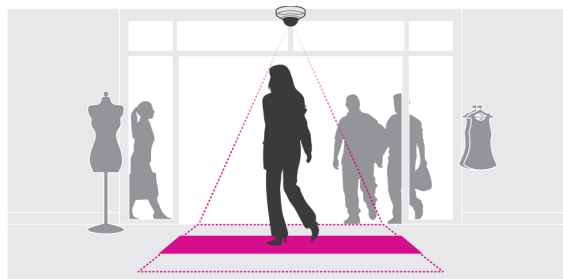

AXIS P14 Network Camera Series

Troubleshooting

Troubleshooting

How to reset to factory default settings

Important

Reset to factory default should be used with caution. A reset to factory default resets all settings, including the IP address, to the factory default values.

To reset the product to the factory default settings:

1. Disconnect power from the product.
2. Press and hold the control button while reconnecting power. See *Product overview*.
3. Keep the control button pressed for 15–30 seconds until the status LED indicator flashes amber.
4. Release the control button. The process is complete when the status LED indicator turns green. The product has been reset to the factory default settings. If no DHCP server is available on the network, the default IP address is 192.168.0.90
5. Use the installation and management software tools to assign an IP address, set the password, and access the video stream.

The installation and management software tools are available from the support pages on axis.com/support

How to check the current firmware

Firmware is the software that determines the functionality of network devices. One of your first actions when troubleshooting a problem should be to check the current firmware version. The latest version may contain a correction that fixes your particular problem.

To check the current firmware:

1. Go to the product's webpage.
2. Click on the help menu. 
3. Click About.

How to upgrade the firmware

Important

Preconfigured and customized settings are saved when the firmware is upgraded (provided that the features are available in the new firmware) although this is not guaranteed by Axis Communications AB.

Note

When you upgrade the product with the latest firmware, the product receives the latest functionality available. Always read the upgrade instructions and release notes available with each new release before upgrading the firmware. To find the latest firmware and the release notes, go to axis.com/support/firmware

1. Download the latest firmware file to your computer, available free of charge at axis.com/support/firmware
2. Log in to the product as an administrator.
3. Go to **Settings > System > Maintenance** in the product's webpage and follow the instructions.
4. The upgrade takes a while, don't break the power to the product. When the upgrade is finished, the product restarts automatically.

AXIS P14 Network Camera Series

Troubleshooting

AXIS Camera Management can be used for multiple upgrades. Find out more at axis.com/products/axis-camera-management

Technical issues, clues and solutions

If you can't find what you're looking for here, try the troubleshooting section at axis.com/support

Problems upgrading the firmware

Firmware upgrade failure	If the firmware upgrade fails, the product reloads the previous firmware. The most common reason is that the wrong firmware file has been uploaded. Check that the name of the firmware file corresponds to your product and try again.
--------------------------	---

Problems setting the IP address

The product is located on a different subnet	If the IP address intended for the product and the IP address of the computer used to access the product are located on different subnets, you cannot set the IP address. Contact your network administrator to obtain an IP address.
--	---

The IP address is being used by another device	Disconnect the Axis product from the network. Run the ping command (in a Command/DOS window, type <code>ping</code> and the IP address of the product): <ul style="list-style-type: none">• If you receive: <code>Reply from <IP address>: bytes=32; time=10...</code> this means that the IP address may already be in use by another device on the network. Obtain a new IP address from the network administrator and reinstall the product.• If you receive: <code>Request timed out</code>, this means that the IP address is available for use with the Axis product. Check all cabling and reinstall the product.
--	---

Possible IP address conflict with another device on the same subnet	The static IP address in the Axis product is used before the DHCP server sets a dynamic address. This means that if the same default static IP address is also used by another device, there may be problems accessing the product.
---	---

The product cannot be accessed from a browser

Cannot log in	When HTTPS is enabled, ensure that the correct protocol (HTTP or HTTPS) is used when attempting to log in. You may need to manually type <code>http</code> or <code>https</code> in the browser's address field.
---------------	--

If the password for the user `root` is lost, the product must be reset to the factory default settings. See *How to reset to factory default settings*.

The IP address has been changed by DHCP	IP addresses obtained from a DHCP server are dynamic and may change. If the IP address has been changed, use AXIS IP Utility or AXIS Camera Management to locate the product on the network. Identify the product using its model or serial number, or by the DNS name (if the name has been configured).
---	---

If required, a static IP address can be assigned manually. For instructions, go to axis.com/support.

Certificate error when using IEEE 802.1X	For authentication to work properly, the date and time settings in the Axis product must be synchronized with an NTP server. Go to Settings > System > Date and time
--	---

The product is accessible locally but not externally

Router configuration	Check that your router allows incoming data traffic to the Axis product. The router must support UPnP®.
----------------------	---

Firewall protection	Check the Internet firewall with your network administrator.
---------------------	--

Problems with streaming

Multicast H.264 only accessible by local clients	Check if your router supports multicasting, or if the router settings between the client and the product need to be configured. The TTL (Time To Live) value may need to be increased.
--	--

AXIS P14 Network Camera Series

Troubleshooting

No multicast H.264 displayed in the client	<p>Check with your network administrator that the multicast addresses used by the Axis product are valid for your network.</p> <p>Check with your network administrator to see if there is a firewall preventing viewing.</p>
Poor rendering of H.264 images	<p>Ensure that your graphics card is using the latest driver. The latest drivers can usually be downloaded from the manufacturer's website.</p>
Color saturation is different in H.264 and Motion JPEG	<p>Modify the settings for your graphics adapter. Go to the adapter's documentation for more information.</p>
Lower frame rate than expected	<ul style="list-style-type: none">• See <i>Performance considerations on page 21</i>.• Reduce the number of applications running on the client computer.• Limit the number of simultaneous viewers.• Check with the network administrator that there is enough bandwidth available.• Lower the image resolution.• In the product's webpage, set a capture mode that prioritizes frame rate. Changing the capture mode to prioritize frame rate might lower the maximum resolution depending on the product used and capture modes available.• The maximum frames per second is dependent on the utility frequency (60/50 Hz) of the Axis product.

Performance considerations

When setting up your system, it is important to consider how various settings and situations affect the performance. Some factors affect the amount of bandwidth (the bitrate) required, others can affect the frame rate, and some affect both. If the load on the CPU reaches its maximum, this also affects the frame rate.

The following factors are the most important to consider:

- High image resolution or lower compression levels result in images containing more data which in turn affects the bandwidth.
- Access by large numbers of Motion JPEG or unicast H.264 clients affects the bandwidth.
- Simultaneous viewing of different streams (resolution, compression) by different clients affects both frame rate and bandwidth.

Use identical streams wherever possible to maintain a high frame rate. Stream profiles can be used to ensure that streams are identical.

- Accessing Motion JPEG and H.264 video streams simultaneously affects both frame rate and bandwidth.
- Heavy usage of event settings affects the product's CPU load which in turn affects the frame rate.
- Using HTTPS may reduce frame rate, in particular if streaming Motion JPEG.
- Heavy network utilization due to poor infrastructure affects the bandwidth.
- Viewing on poorly performing client computers lowers perceived performance and affects frame rate.
- Running multiple AXIS Camera Application Platform (ACAP) applications simultaneously may affect the frame rate and the general performance.

AXIS P14 Network Camera Series

Specifications

Specifications

To find the latest version of the product's datasheet, go to axis.com > [product] > Support & Documentation.

LED Indicators

Status LED	Indication
Unlit	Connection and normal operation.
Green	Shows steady green for 10 seconds for normal operation after startup completed.
Amber	Steady during startup. Flashes during firmware upgrade or reset to factory default.
Amber/Red	Flashes amber/red if network connection is unavailable or lost.
Red	Firmware upgrade failure.

SD card slot

NOTICE

- Risk of damage to SD card. Do not use sharp tools, metal objects, or excessive force when inserting or removing the SD card. Use your fingers to insert and remove the card.
- Risk of data loss and corrupted recordings. Do not remove the SD card while the product is running. Unmount the SD card from the product's webpage before removal.

This product supports microSD/microSDHC/microSDXC cards (not included).

For SD card recommendations, see axis.com

Buttons

Control button

The control button is used for:

- Resetting the product to factory default settings. See *How to reset to factory default settings on page 19*.
- Connecting to an AXIS Video Hosting System service. To connect, press and hold the button for about 3 seconds until the status LED flashes green.

Connectors

Network connector

RJ45 Ethernet connector with Power over Ethernet (PoE).

I/O connectors

Use the I/O connector with external devices in combination with, for example, tampering alarms, motion detection, event triggering, and alarm notifications. In addition to the 0 V DC reference point and power (DC output), the I/O connector provides the interface to:

Digital output – For connecting external devices such as relays and LEDs. Connected devices can be activated by the VAPIX® Application Programming Interface or in the product's webpage.

AXIS P14 Network Camera Series

Specifications

Digital input – For connecting devices that can toggle between an open and closed circuit, for example PIR sensors, door/window contacts, and glass break detectors.

4-pin terminal block

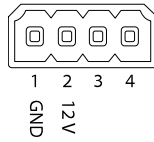

Connection Diagrams

I/O Connector

Note

Valid for AXIS P1435-LE Network Camera

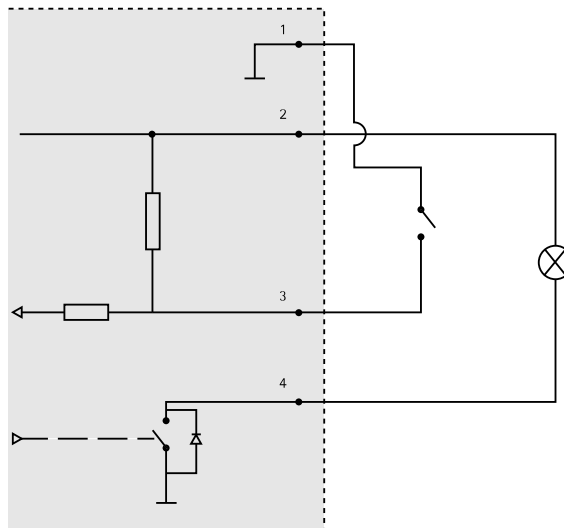

- 1 0 V DC (-)
- 2 DC output 12 V, max 25 mA
- 3 Digital input
- 4 Digital output

