



Discreet. Flexible. Hemispheric.

With the S15D FlexMount, one or two sensor modules (6MP/5MP, Day/Night/Night-LPF/Thermal) are connected to a concealed camera housing via cables up to 3 m/9.8 ft long. Two adjacent rooms can be discreetly monitored with only one camera.



Innovations – Made in Germany

The German company MOBOTIX AG is known as the leading pioneer in network camera technology and its decentralized concept has made high-resolution video systems cost efficient.

MOBOTIX AG • D-67722 Langmeil • Phone: +49 6302 9816-103 • Fax: +49 6302 9816-190 • sales@mobotix.com

 6MP
Sensor

 MxLEO

 360°

 50 mK

 VPTZ

 MxBus

 USB

 +60°
-30°

 IP65

THE MOBOTIX INFORMATION CHANNELS



Support on the MOBOTIX Website
www.mobotix.com/other/Support



The MOBOTIX Video Tutorials
www.mobotix.com/other/Support/Tutorials



Seminars on MOBOTIX Campus
www.mobotix.com/other/Partners/Seminars



The MOBOTIX YouTube Channel
www.youtube.com/MOBOTIXAG



MOBOTIX Seminars

MOBOTIX offers inexpensive seminars that include workshops and practical exercises. For more information, visit www.mobotix.com > **Seminars**.

Copyright Information

All rights reserved. MOBOTIX, the MX logo, *MxControlCenter*, *MxEasy* and *MxPEG* are trademarks of MOBOTIX AG registered in the European Union, the U.S.A., and other countries. *Microsoft*, *Windows* and *Windows Server* are registered trademarks of Microsoft Corporation. *Apple*, the Apple logo, *Macintosh*, *OS X*, *iOS*, *Bonjour*, the Bonjour logo, the Bonjour icon, *iPod* and *iTunes* are trademarks of Apple Inc. registered in the U.S.A. and other countries. *iPhone*, *iPad*, *iPad mini* and *iPod touch* are Apple Inc. trademarks. *Linux* is a trademark of Linus Torvalds. All other marks and names mentioned herein are trademarks or registered trademarks of the respective owners.

Copyright © 1999-2015 MOBOTIX AG, Langmeil, Germany. Information subject to change without notice!

Download the latest version of this and other manuals as PDF files from www.mobotix.com > **Support** > **Manuals**.

1	Product Overview	10
1.1	S15 FlexMount	10
1.1.1	S15M FlexMount Camera	12
1.1.2	S15D FlexMount Dual Camera	13
1.1.3	Advantages and New Features	16
1.1.4	Hemispheric Technology	18
1.1.5	Decentralized Video System	22
1.2	Technical Specifications	24
1.2.1	S15M Lens Options	24
1.2.2	S15D Lens Options	24
1.2.3	S15D with Thermal Sensor Modules	27
1.2.4	Camera Variants – Lenses, Hardware, Image Formats	28
1.2.5	Camera Variants – Software Features	29
1.2.6	Technical Data	30
1.3	Delivered Parts and Dimensions	34
1.3.1	S15D Core (Base Module)	34
1.3.2	Sensor Modules L10-L12*	40
1.3.3	Sensor Modules L20-L23, L22-L25, L32-L38, L43-L51, L65-L76, L135-L160*	42
1.3.4	Sensor Modules L270-L320*	44
1.3.5	BlockFlexMounts L10-L12, L20-L23, L22-L25, L32-L38, L43-L51, L65-L76, L135-L160, L270-L320*	46
1.3.6	BlockFlexMount CS Mount	48
1.3.7	Thermal Sensor Modules L43, L65, L135	50
1.3.8	S15M	52
1.4	Available Accessories	58
1.4.1	Extension for Sensor Module	58
1.4.2	Ceiling/Wall Installation Set	58
1.4.3	Connection Cable for Sensor Module	58
1.4.4	MiniUSB Cable to MiniUSB (Straight/Straight or Straight/Angled)	58
1.4.5	MiniUSB Cable to USB a Socket	59
1.4.6	Ethernet Patch Cable for Bayonet Catch	59
1.4.7	NPA-PoE-Set	59
1.4.8	MX-Overvoltage-Protection-Box	59
1.4.9	MX-NPA-Box	60
1.4.10	MX-GPS-Box	60
1.4.11	MX-232-IO-Box	60
1.4.12	ExtIO Expansion Module	61
1.4.13	Mx2wire+ Media Converter	61
1.4.14	AudioMount	61
1.4.15	DualMount	62
1.4.16	SurroundMount	62
1.4.17	HaloMount	62
1.4.18	SpeakerMount	63

1.4.19	PTMount	63
1.4.20	Sealing Ring as Dome Replacement for Sensor Modules L10-L12	63
1.4.21	Other Accessories	63
1.5	MOBOTIX Software	65
1.5.1	Integrated Camera Software (Firmware)	65
1.5.2	MxControlCenter	66
1.5.3	MxEasy	67
1.5.4	MOBOTIX App	68
2	Installation	70
2.1	Determining the Installation Position	70
2.1.1	Positioning a Hemispheric Camera	71
2.1.2	S15D FlexMount Installation Options	76
2.1.3	S15M FlexMount Installation Options	83
2.2	Before Mounting	84
2.2.1	Overview of Cable Connections	84
2.2.2	Notes on Cable Lengths and Power Supply	86
2.2.3	Network Connection with MOBOTIX Patch Cable	87
2.2.4	Network Connection with Installation Cable	88
2.2.5	Using Sensor Modules (S15D Only)	88
2.2.6	Using the MiniUSB Cable	88
2.2.7	Using MxBus Modules	89
2.2.8	External Audio Support (Microphone/Speaker)	89
2.2.9	Replacing the MicroSD Card	90
2.2.10	Tools Required for Installation	90
2.2.11	Preparatory Steps	91
2.3	Installing the S15D FlexMount	92
2.3.1	Attaching the S15D Base Module	92
2.3.2	Attaching and Connecting the S15D Sensor Modules	93
2.3.3	Plugging in and Removing Extensions	94
2.3.4	Connecting Network Cables and Additional S15D Cables	95
2.4	Installing the S15M FlexMount	96
2.4.1	Connecting Network Cables and Additional S15M Cables	96
2.4.2	Attaching the S15M Camera Housing	96
2.5	Network and Power Connection, Additional Cables	98
2.5.1	Network Cabling for S15 with Patch Cables	98
2.5.2	Network Cabling for S15 with Installation Cables	99
2.5.3	Connecting Additional Cables	101
2.5.4	Power Supply Using a Switch	102
2.5.5	Power Supply When Connected Directly to a Computer	103
2.5.6	Power Supply with Power-Over-Ethernet Products	103
2.5.7	Variable PoE	104
2.5.8	Camera Startup Sequence	105

3	Operating the Camera	106
3.1	Manual and Automatic Operation	106
3.1.1	Manually Using a Computer in the 10.x.x.x IP Address Range	107
3.1.2	Automatically Using MxControlCenter or MxEasy	108
3.1.3	Automatically Using DHCP	109
3.2	First Images and the Most Important Settings	110
3.2.1	Manually Setting Up the Network Parameters in a Browser	110
3.2.2	First Images and the Most Important Settings in the Browser	112
3.2.3	First Images and Network Parameter Configuration in MxControlCenter	114
3.2.4	First Images and Network Parameter Configuration in MxEasy	119
3.2.5	Starting the Camera with the Factory IP Address	122
3.2.6	Starting the Camera with an Automatic IP Address (DHCP)	123
3.3	Adjusting Lens Focus and Inserting a Filter	124
3.3.1	Adjusting Lens Focus (L65-L76/L135-L160 Only)	124
3.3.2	Inserting a Filter	125
3.3.3	Replacing the Dome Against the Sealing Ring (Only Sensor Modules L10-L12)	126
3.4	Virtual PTZ and Full Image Recording	128
3.4.1	Preparing the Virtual PTZ Function	128
3.4.2	Full Image Recording	130
3.4.3	Special S15 Configuration in the Browser	132
3.5	MicroSD Card Recording	142
3.5.1	Introduction	142
3.5.2	Formatting the MicroSD Card	144
3.5.3	Activating MicroSD Card Recording	145
3.5.4	Accessing Data on the MicroSD Card	146
3.5.5	Deactivating Card Recording	146
3.5.6	Using a MicroSD Card in a Different MOBOTIX Camera	147
3.5.7	Limitations on Warranty When Using Flash Storage Media	147
3.6	Configuration in the Browser	148
3.6.1	Overview	148
3.6.2	General Browser Settings	150
3.6.3	Settings When Using Thermal Sensor Modules	151
3.7	Special Case: Setting Up an S15 FlexMount as a Door Station	152
3.7.1	Installation	152
3.7.2	Execute Auto Configuration	153
3.7.3	Setting Up an S15 as a Door Station	154
3.8	Additional Notes	155
3.8.1	Do Not Sharply Bend the Connection Cables to the Sensor Modules	155
3.8.2	Reduced Weather Protection When Installing Upside-Down	155
3.8.3	Password for the Admin Menu	155
3.8.4	Permanently Deactivating the Microphone	156

3.8.5	Starting the Camera with the Factory IP Address	156
3.8.6	Resetting the Camera to Factory Settings	156
3.8.7	Activating Event Control and Motion Detection	156
3.8.8	Deactivating Text and Logo Options	157
3.8.9	Deactivating the Camera Reboot	157
3.8.10	Browser	157
3.8.11	Cleaning the Camera and Lens	157
3.8.12	Legal Notes	158
3.8.13	Safety Warnings	158
3.8.14	Online Help in the Browser	159
3.8.15	RoHS Declaration	159
3.8.16	Disposal	159
3.8.17	Disclaimer	160

Manufacturer

163

Legal Notes

Attention – Special Export Regulations Apply! Cameras with thermal image sensors (“thermal cameras”) are subject to the special export regulations of the U.S.A. and the ITAR (International Traffic in Arms Regulation):

- **According to the currently applicable export regulations of the U.S.A. and the ITAR, cameras with thermal image sensors or parts thereof must not be exported to countries embargoed by the U.S.A. or the ITAR. At present, this applies to the following countries: Syria, Iran, Cuba, North Korea and Sudan. The same export ban applies to all persons and institutions listed in “The Denied Persons List” (see www.bis.doc.gov > Policy Guidance > Lists of Parties of Concern).**
- **Under no circumstances can the camera itself or its thermal image sensors be used in the design, the development or in the production of nuclear, biological or chemical weapons or in the weapons themselves.**

Legal aspects of video and sound recording: You must comply with all data protection regulations for video and sound monitoring when using MOBOTIX products. Depending on national laws and the installation location of the S15, the recording of video and sound data may be subject to special documentation or it may be prohibited. All users of MOBOTIX products are therefore required to familiarize themselves with all valid regulations and comply with these laws. MOBOTIX AG is not liable for any illegal use of its products.

Safety Warnings

Installation Instructions:

- This product must not be used in locations exposed to the dangers of explosion.
- Make sure to install this product as shown in *Chapter 2, «Installation»* of this manual.
- When installing this product, make sure that you are only using genuine MOBOTIX parts and MOBOTIX connection cables.
- Make sure that you are installing this product on a solid surface that provides for a sturdy installation of the fixing elements used.

Electrical installation: Electrical systems and equipment may only be installed, modified and maintained by a qualified electrician or under the direction and supervision of a qualified electrician in accordance with the applicable electrical guidelines. Make sure to properly set up all electrical connections.

Electrical surges: MOBOTIX cameras are protected against the effects of small electrical surges by numerous measures. These measures, however, cannot prevent the camera from being damaged when stronger electrical surges occur. Special care should be taken when installing the camera outside of buildings to ensure proper protection against **lightning**, since this also protects the building and the whole network infrastructure.

Max. power consumption of attached extension modules: The power consumption of all attached **MxBus modules** must **not exceed 3 W**. When attaching modules to the MxBus connector **and** the USB connector, the **power consumption of all attached modules must not exceed 4 W, if the camera is powered by PoE class 3**. If **PoE class 2** is used, **the power consumption of all attached modules must not exceed 1 W!** If thermal sensor modules are used with this camera, **PoE Class 3 is required** and **the power consumption of all attached modules (MxBus and USB) must not exceed 1 W**.

Never touch the dome or the protective lens covers: Due to the high performance of the S15, the area of the image sensor **can get quite hot**, especially when the ambient temperature is also high. This does not affect the proper functioning of the camera in any way. For this reason, the product must not be installed within the reach of persons without domes or protective lens covers.

Only exchange sensor modules when powered off: Make sure that the camera's power supply has been disconnected before attempting to exchange any sensor modules.

Network security: MOBOTIX products include all of the necessary configuration options for operation in Ethernet networks in compliance with data protection laws. The operator is responsible for the data protection concept across the entire system. The basic settings required to prevent misuse can be configured in the software and are password-protected. This prevents unauthorized parties from accessing these settings.



FOREWORD

Dear MOBOTIX customer,

Congratulations on purchasing a professional and state-of-the-art HiRes network camera "Made in Germany." MOBOTIX is proud to present the S15 FlexMount, a weatherproof and flexible system characterized above all by its extremely discreet installation options.

In the **dual camera S15D variant** one or two sensor modules (lens with a sensor board, LEDs and microphone) are connected to the base module using cables that can be up to three meters long. The flat housing with integrated long-term flash memory and external connectors (Ethernet, MiniUSB, MxBus, audio) can be installed discreetly and with optimal protection behind a wall or ceiling panel so that only the lenses are visible in the room. **Sensor modules** are available with 5MP and 6MP resolution: from tele lens to Hemispheric, each available as day or night models, in black or white.

The **BlockFlexMounts** represent the same sensor modules in a different housing that has been designed especially for integration into any given structure or device. The additional mounting options (DualMount, SurroundMount, HaloMount, PTMount) provide the highest flexibility when installing the modules.

When using the **Thermal Sensor Modules**, the S15 can use its state-of-the-art video sensors to reliably detect movements even in total darkness. Thanks to their precision of 50 mK (0.02°C), these sensors offer a degree of detail that is by far superior than comparable products.

The **S15M camera variant** has a hemispheric sensor module (day or night) that is integrated into the camera housing. This camera can also be placed discreetly and securely behind walls and ceilings or stainless steel panels (using the AudioMount, for example). If a speaker is required, why not use the SpeakerMount for easy installation into ceilings or walls?

The introduction of the newest image sensor technology with increased light sensitivity in combination with the new HD Premium lenses (f/1.8) provides brilliant images with image sizes of up to 3072x2048 pixels (6MP)/2592x1944 (5MP), thus delivering color images of higher quality under lowlight conditions. In addition, the LPF ("Long Pass Filter") variants of the night variants have been designed for special requirements (such as number plate recognition, for example).

The **MxEasy** and **MxControlCenter** video management software, which is tailored to MOBOTIX cameras, and a PDF manual can be downloaded from the MOBOTIX website at no cost: www.mobotix.com > **Support** > **Software-Downloads**. MOBOTIX also provides mobile solution for the iPad, iPhone and iPod Touch mobile iOS devices. Search for "MOBOTIX" in the App Store to find the free app.

If you still have any questions, our support and international sales staff are available at intl-support@mobotix.com from Monday to Friday, 8 a.m. to 6 p.m. (German time).

We would like to thank you for your trust and wish you all the best with your new MOBOTIX camera S15 FlexMount.



**S15D – One Camera, Two Surveillance Areas:
Indoor Entrance Area (Left) and Outdoor Entrance Area (Right)**



**S15M – Camera with Hemispheric Sensor Module for Concealed
Installation Behind a Wall or Ceiling Panel**



1 PRODUCT OVERVIEW

1.1 S15 FlexMount



Perfect When Discretion Is Needed

Some application scenarios benefit from a surveillance camera that is present, but does not attract attention. Available in both single-lens and dual versions, the cameras feature a discreet appearance, enabling a flexible range of applications.



The easily concealable camera housing makes every S15 system the ideal solution wherever discreet design and appearance are paramount. Digital network cameras without mechanical moving parts require low maintenance. In addition, they are silent when panning and focusing on a specific image area. As a result, typical applications for these cameras are installations in hotels and restaurants, public and private buildings, waiting rooms, showrooms, parking garages, storage rooms and exhibition booths.

Fast, Simple Cabling

The MOBOTIX S15 FlexMount requires just one cable for data and power to connect to a PoE switch and thereby to any expandable Ethernet network. There are two options for a weatherproof connection of the network cable to the housing. A MOBOTIX patch cable up to 10 meters in length can be plugged externally into the housing from below and secured with a weatherproof bayonet catch, or the eight individual strands of the installation cable can be attached directly to the LSA cutting clamp inside the camera housing.

A number of additional devices can be used together with the S15. They are connected via a network switch or directly to the camera housing via a MxBus or MiniUSB cable (for example, ExtIO, MOBOTIX interface boxes, audio devices, flash drives or UMTS/WiFi USB modems). If the network switch also features an Internet connection, it can be used for encrypted access to the camera footage from anywhere in the world.

The entire camera plus cables and sensor modules are weatherproof (!) and operate in a temperature range of -30 to $+60$ °C/ -22 to $+140$ °F. Because the S15 never fogs up and does not require any heating, it can be operated all year round with power supplied via a standard PoE network cable. Power consumption is less than five watts.

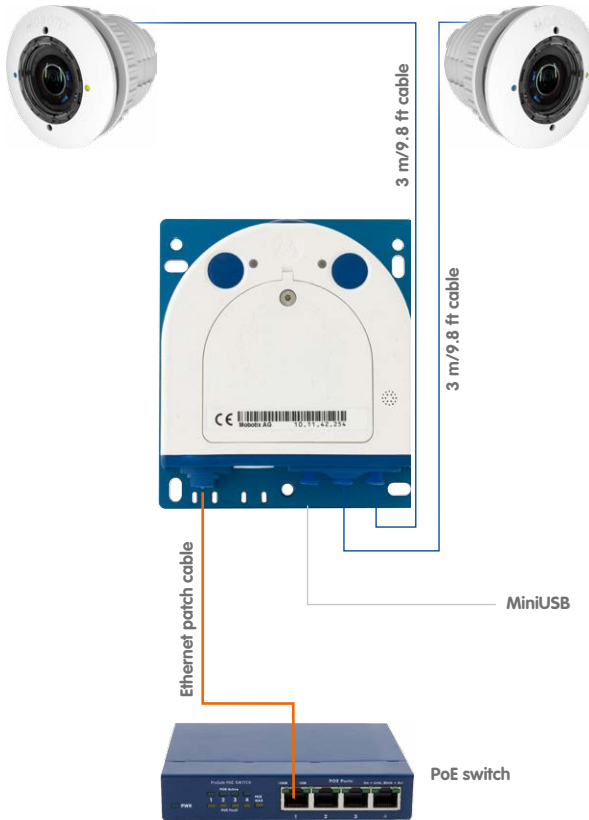

Sensor modules including status LEDs and microphone

Note

S15D Complete Sets

MOBOTIX also offers fully equipped **S15D sets** with one or two sensor modules. For more information, see the MOBOTIX website (www.mobotix.com) or contact your MOBOTIX partner directly.

1.1.1 S15M FlexMount Camera

Almost Completely Concealable Hemispheric Camera

The S15M is the compact single-lens version of the S15 series (M = mono). With this version, (only one) hemispheric lens (L10 – 6MP, L12 – 5MP) is screwed directly to the camera housing, which can be concealed behind a cover or cladding (for example, stainless steel) up to 6.4 mm in thickness. Thicker surfaces may also be suitable for mounting the if they can be hollowed out accordingly.



New 6MP/5MP Images Sensors In The Day Or Night Model

The S15M features a high-resolution color or black and white sensor with 3072x2048 (6MP) or 2592x1944 (5MP) pixels for installation under all lighting conditions (day = color, night = black and white). If needed, external microphone and/or speaker units can be directly connected to the camera via suitable IO terminals.

1.1.2 S15D FlexMount Dual Camera

Dual Images Up to Twelve Megapixels in Size

The S15D (D = dual), the second version, features one or two sensor modules, each with an integrated microphone and two status LEDs, which can be connected to the core module via cables up to 3 meters long. The sensor modules are supplied preassembled for ceiling or wall mounting. The visible external part of the sensor module is available in white or black, enabling it to blend into most installation environments.



The S15D can take up to two HiRes image sensors with 3072x2048 (6MP) or 2592x1944 (5MP) pixels, which can be combined to output a color dual image up to 12 megapixels in size. The system can be fitted with any combination of day, night, night LPE, thermal or BlockFlexMount sensor modules. The maximum frame rate can be up to 30 frames per second, depending on the resolution selected.

On www.mobotix.com go to **Products > S15 FlexMount** and open the basket. It contains a **Product Configurator**, Use this to order the required parts in any of the available colors.



Day and Night Sensor in One Camera

The difference between a MOBOTIX day/night camera and the standard versions is primarily that it continuously uses two adjacent sensor modules rather than relying on a mechanical filter switch, which can be costly to maintain. The other advantage is much better image quality in poor lighting conditions, as the camera uses a real infrared-sensitive, black-and-white image sensor instead of the usual color sensor with electronic color fade-out, whereby the infrared sensitivity is reduced through integrated color filters.

Double Hemispheric Camera S15D

When an S15D with two hemispheric sensor modules is deployed, they can be installed in different mounting positions (ceiling, wall, floor), even in different rooms, if needed. Each sensor module offers the full range of functions provided by a hemispheric camera. The day/night versions of the sensor modules can be freely combined in installation (including automatic day/night switching for the same viewing angle).

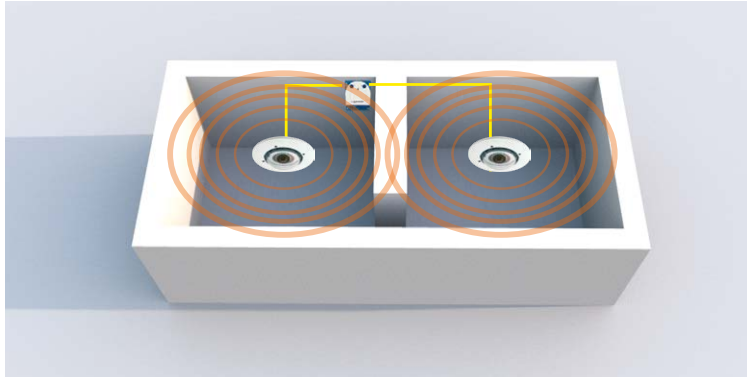

Separate Housing and Lens Installation – Weatherproof According to IP65

The flat housing of the S15 FlexMount, including long-term flash memory (MicroSD , SDXC) and all internal and external connectors (Ethernet, MiniUSB, MxBus, microphone, speaker), can be installed discreetly and with optimal protection behind a wall or ceiling panel. Only the small round fronts of the sensor modules, which are 50 mm in diameter, are visible in the room.

Mounting the recessed sensor modules of the S15D is extremely easy: Plug the connection cable into the sensor module and secure it with the bayonet catch, attach the hinged ferrite, drill a circular hole (diameter: at least 43 mm), feed through the cable and sensor module from the front, secure it with a nut, plug the connection cable into the core module and secure it with a nut, plug the connection cable into the core module and secure it. You're done!

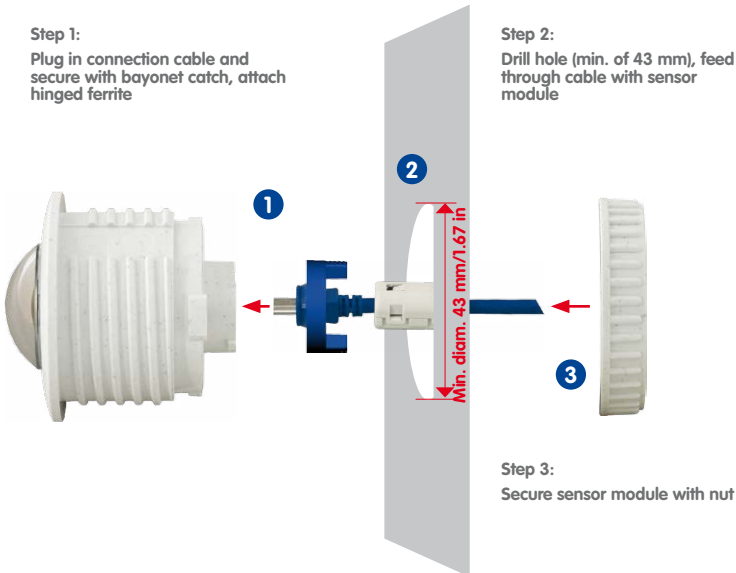

Sensor modules can be replaced any time

Flexible and Future-Proof

The system can easily be matched to suit the location's requirements, thanks to a range of available sensor modules. Replacing the sensor modules at a later stage to change the focal lengths is quick and easy, as is upgrading from one to two sensor modules.

1.1.3 Advantages and New Features

The high-resolution S15 FlexMount is a universally deployable, highly innovative and easily concealable camera system. A powerful successor to the S14, the S15 features five-megapixel image sensors. Since the live or recorded images displayed by an S15 sensor have a maximum size of 3072x2048 (6MP) bzw. 2592x1944 (5MP) pixels, the S15 is clearly superior to the previous model in terms of image quality and frame rate.

Smooth HiRes Video Streams

The modified hardware of the S15 transmits the camera's video streams even more smoothly than the high-performance S14, even when high resolution is required. Since image streams of 16 frames per second and higher are perceived as smooth video by the human eye, the maximum frame rate is limited to 30 frames per second (when using MEGA resolution of 1280x960) in order to provide sufficient camera processing power for other tasks.

Conclusive Still Images

Thanks to the proprietary MxPEG video codec developed exclusively for MOBOTIX cameras, the cameras offer the advantage that a recording can be paused at any given point and still provide meaningful and useful snapshots due to the absence of distortion. This is essential for security applications and allows individuals or license plates to be identified, for example. In contrast, the H.264 standard, which was developed for feature movies and is favored by some video security providers, cannot achieve this with the required level of quality.

Good Color Images Even in Low Light

The more light-sensitive an image sensor is, the better the image quality, especially when the ambient light level is low, such as at dusk and in heavy rainfall. The S15 offers the best MOBOTIX image quality that is currently available thanks to the light sensitivity provided by the five-megapixel color sensor that is four times higher than that of the previous three-megapixel color sensor.

More Details When Zooming

The maximum zoom factor of the S15 is 1.26 times higher than that of the S14 due to the use of five-megapixel technology. This means that the degree of detail provided by the camera has improved by 26 percent. As a result, an S15 can now be installed even further away than before from the objects and areas to be monitored.

Black and White Images Now Up to 6 Megapixels in Size

The S15 is the first MOBOTIX camera worldwide to also feature a 6MP night sensor that can deliver black and white images up to 3072x2048 pixels in size. This means that the image resolution is more than four times higher than the predecessor's night image sensor with 1.3 megapixels.

World's first Dual Thermal Camera

The new thermal sensor modules measure the thermal radiation of objects, delivering clear thermal images even in absolute darkness. Together with the MxActivitySensor, they can reliably detect motion in images at night – where only changes in position will trigger a signal. Objects moving on the spot do not trigger a signal. The thermal sensor modules also have an advantage during the day, as they can detect moving objects in shadows, semi-darkness, smoke or behind bushes.

MxActivitySensor

The S15 provides an activity-controlled image analysis sensor as standard for detecting the movements of people and objects in a defined surveillance area (full image or section). The MxActivitySensor delivers reliable results particularly in outdoor area applications, in contrast to video motion detection that continues to be available and that registers all image changes in defined video motion windows. In the monitored area, the camera distinguishes between the continuous movements of vehicles, persons or objects that trigger an alarm and movements that do not set off an alarm such as shadows, changing light conditions and trees swaying in the wind.

MOBOTIX Mounts – Flexible Installation Options

Whether in ceilings, behind faceplates or built into other devices, the MOBOTIX mounts provide flexible solutions for every application scenario. The HaloMount installs sensor modules into ceilings as easily as halogen spot lamps, the SpeakerMount with integrated speaker provides the audio output. If two sensor modules are to be installed side-by-side with the same viewing direction, you can use the DualMount (e.g. for Day/Night sensor modules). Two sensor modules looking into opposite directions? This is calling for the SurroundMount (e.g. for long hallways). The AudioMount, complete with installed S15M is glued to the back of a faceplate in order to provide door station functionality. The BlockFlexMount sensor modules allow installing the S15D with up to two sensor modules into any device.

Low Power Consumption in Accordance with the PoE Standard (IEEE 802.3af)

An S15 uses no more power than its predecessor (typically 4.5 watts), despite the new sensor technology. Adjusting the PoE class via the camera software also enables the use of PoE switches that cannot be operated on all ports with PoE class 3 (up to max. 12.95 V). If an S15D is used with one or two thermal sensor modules, PoE Class 3 is required.



1.1.4 Hemispheric Technology

Featuring one (S15M) or two hemispheric lenses (S15D), offers all the image views known from MOBOTIX' other hemispheric cameras, including *Panorama*, *Panorama Focus*, *Double Panorama*, *Full Image*, *Normal* and *Surround*. What's new on the S15D is that the selected view can be displayed as a dual image that combines both sensor modules.

The primary components of a hemispheric camera include a fisheye lens, a high-resolution image sensor, and image correction software that is integrated into the camera. Using an ultra-wide angle lens, the hemispheric camera captures a 180°-hemispheric image of the room and projects it onto a high-resolution image sensor.

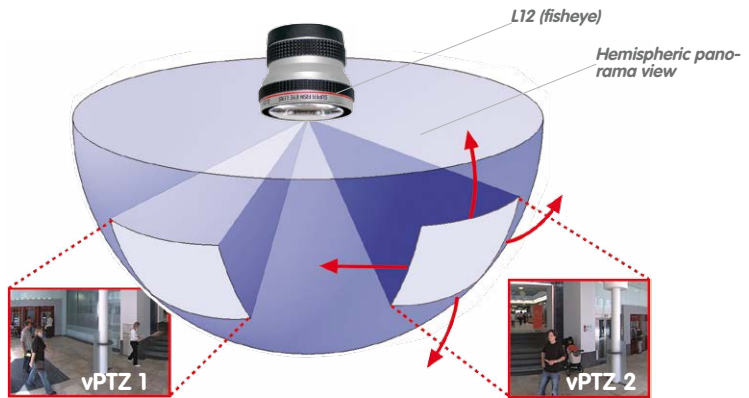

When ceiling mounted, the image area of the hemispheric camera covers the entire room. The image in the hemisphere is convex, particularly near the image borders. These image sections are corrected for the viewer by the integrated distortion correction software, allowing a view of the scene from the usual perspective. The virtual PTZ feature allows you to enlarge or move image sections within the hemisphere just like PTZ camera, yet without the need for mechanical moving parts. Hemispheric cameras lack mechanical moving parts and require low maintenance. In addition, they are silent when panning and focusing on a specific image area.

Handle Several Image Sections at Once

One or more image sections can be corrected for perspective in the hemispheric view, allowing you to monitor and record several different areas of a room at the same time, something that a mechanical PTZ camera is not capable of doing.



Everything Stored in the Recording

Traditional optical PTZ cameras can only record what is being viewed live. The virtual PTZ feature from MOBOTIX allows users to pan to other areas at a later stage in the recording because the **entire room** can be recorded as a hemispheric image.

S15D: Perfect Overview in Two Rooms, Day and Night

A world first, the S15D provides the option of using two hemispheric sensor modules within a single camera. This way, two entirely separate spaces – next to or on top of each other, indoors or outdoors – can be secured simultaneously using just one camera.

The S15D can also be used as a hemispheric day/night camera. The black-and-white and color sensor modules are mounted directly next to each other so they cover the same area (we recommend an installation with DualMount MOBOTIX accessory). The camera automatically chooses the best available mode depending on the lighting conditions: either the color sensor with daylight lens or the black and white image sensor with infrared lens

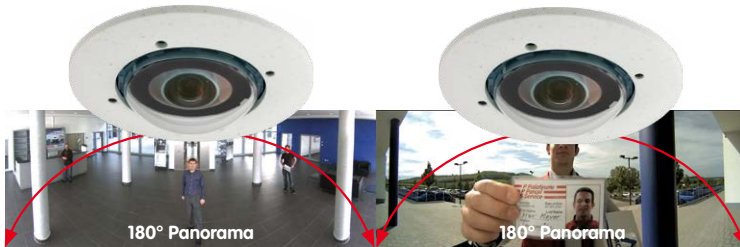

Dual image up to 12 megapixels in size

Special Hemispheric Image Views

Panorama

The hemispheric image (original full image) can also be transformed into an ultra-wide angle panoramic view if the camera is mounted on a wall, providing a view of the room without any blind spots from wall to wall. It offers a substantially better view of the scene, compared to other cameras, and it also results in the need for fewer cameras overall.



Panorama Focus

Maximum room overview while simultaneously viewing detail in a single image. A hemispheric sensor module can also provide two additional views so that you can focus on two detail scenes simultaneously in addition to the panorama view.

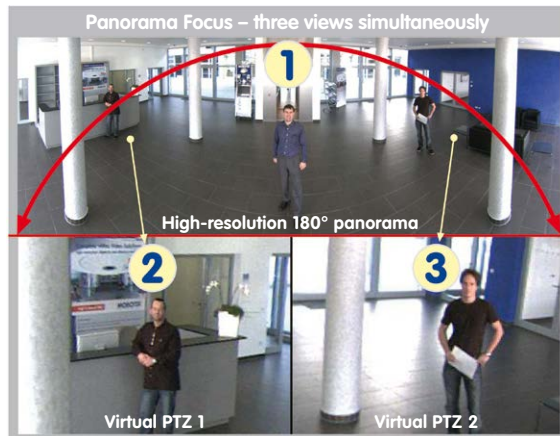

Original full image

Double Panorama

When the camera is mounted in the center of the ceiling in a room, the “Double Panorama” display mode provides a corrected panorama image of both halves of the room. It corresponds roughly to the situation of personally standing in the middle of the room and being able to look both forwards and backwards at the same time. This is a superb overview for the user – provided by a single sensor module.



Original full image



1.1.5 Decentralized Video System

Usually, cameras only supply images, while processing and recording take place later on a central PC using video management software. This centralized structure has too many limitations for high-resolution video systems since it requires high network bandwidth and the PC processing power is insufficient when using several high-resolution cameras. Due to the large number of computers and servers required, traditional centralized systems are therefore becoming less suitable and cost effective.

As part of the decentralized MOBOTIX concept, every camera features a **high-speed processor**, and, if necessary, digital **long-term flash memory** (MicroSD card) can be integrated to provide several days of recording time. The computer or video control center is required only to view and control the cameras, not to evaluate and record video. This means that you do not have to rely on expensive, overloaded video management software as most of the important functions that require a large amount of processing power are integrated into the MOBOTIX cameras themselves.

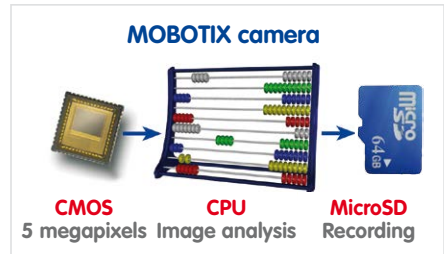

Integrated sensors enable MOBOTIX cameras such as the S15 to automatically detect when an event has occurred. If necessary, the cameras will respond immediately with an alarm sound and will establish a direct video and sound connection to a control room.

The S15 is equipped with a **shock detector** as standard (for all IT and Secure models). For example, if the camera receives a blow to the housing, it can simultaneously take a video of the offender, trigger a sound alarm and notify the security company by a SIP call. Due to the build quality and absence of moving parts, MOBOTIX cameras are extremely tough. This typically allows them to stay fully operational especially when they are subject to strong vibrations.

All MOBOTIX cameras are **backlight-proof** and are not adversely affected by the glare from direct sunlight. They deliver meaningful, detailed images at all times as the camera software supports easy programming of independent exposure windows, making them ideal for rooms with large glass fronts.

In the event of an alarm, MOBOTIX S15 cameras can also record lip-synchronous audio. The cameras therefore play an important role in analyzing and clarifying a situation. Thanks to an integrated speaker and microphone, each individual camera can also be used for bidirectional communication (two-way video communication), so you can easily use the MOBOTIX App with your iPhone or iPad on the road.

The decentralized **MOBOTIX video solutions** are superior to traditional systems in all major aspects. They are also considerably cheaper to operate since they require

- **Fewer cameras** due to the more accurate detail of panorama images with mega-pixel technology
- **Fewer recording devices** because in the decentralized system, ten times the standard number of cameras can be used to record high-resolution HDTV video with sound on one computer/server simultaneously
- **Lower network bandwidth** because everything is processed in the camera itself and the high-resolution images therefore do not have to be constantly transported for analysis



MOBOTIX System
Decentralized and secure



Recording software



PC as storage device

1.2 Technical Specifications

1.2.1 S15M Lens Options

Since **MOBOTIX** cameras are **backlight-proof**, **none of the lenses requires a mechanical auto iris**. This makes the cameras extremely robust and maintenance-free.

S15M with L10* (6MP) or L12 (5MP) Hemispheric Fisheye Lens

The S15M is shipped with one hemispheric fisheye lens and is available in a day or night version, making it ideal for installing behind covers or this walls. Combined with the «AudioMount» (microphone and speaker integrated), you can set up an alternative door station.



*S15M with 6MP image sensor available later in 2015



Full image with L10-L12 fisheye in public transit bus

1.2.2 S15D Lens Options

One or two optical image sensors can be used with the S15D (in the form of sensor modules or as BlockFlexMount). The image sensors are available as 6MP and 5MP image sensors with different angles of view:

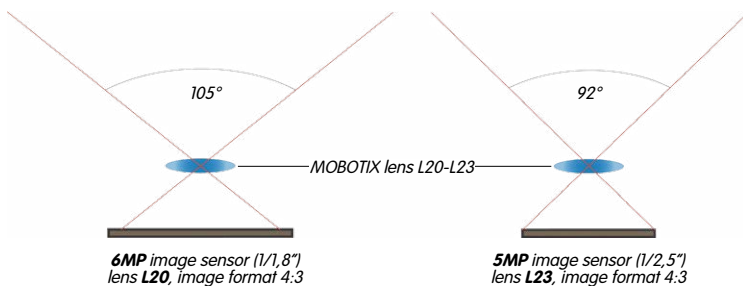

Focal Lengths of MOBOTIX Lenses

The focal lengths of MOBOTIX lenses are always relating to 35 mm camera format. For example, the MOBOTIX L20-L23 Super Wide-Angle lens has a true focal length of 3.6 mm. Converted to 35 mm format, this translates to a 20 mm lens on a 6MP image sensor and a 23 mm lens on a 5MP image sensor. You can use this focal length to easily compare image formats and angles of view. In addition, you can set this value on common 35 mm or digital still cameras to the focal length (Lxx) of a MOBOTIX lens to check if the resulting image suits the requirements for this camera.

Lenses for S15D Modules with 6MP Image Sensor

Lenses with 6MP Image Sensor	L10	L20	L22	L32	L43	L65	L135	L270
Original image (image format 4:3)								
35 mm equiv.	10 mm	20 mm	22 mm	32 mm	43 mm	65 mm	135 mm	270 mm
True focal length	1.8 mm	3.6 mm	4 mm	6 mm	8 mm	12 mm	25 mm	50 mm
Aperture	2.0	1.8	1.8	1.8	1.8	1.8	1.8	2.5
Horizontal angle of view	180°	105°	90°	60°	45°	31°	15°	8°
Vertical angle of view	180°	77°	67°	45°	34°	23°	11°	6°
At 1 m distance								
Image width	∞	2.6	2.0	1.2	0.8	0.6	0.3	0.1
Image height	11.3	1.6	1.3	0.8	0.6	0.4	0.2	0.1
At 2 m distance								
Image width	∞	13.0	10.0	5.8	4.1	2.8	1.3	0.7
Image height	56.7	8.0	6.6	4.1	3.1	2.0	1.0	0.5
At 10 m distance								
Image width	∞	26.1	20.0	11.5	8.3	5.5	2.6	1.3
Image height	113.4	15.9	13.2	8.3	6.1	4.1	1.9	1.0
At 20 m distance								
Image width	∞	52.1	40.0	23.1	16.6	11.1	5.3	2.6
Image height	226.9	31.8	26.5	16.6	12.2	8.1	3.9	1.9
At 50 m distance								
Image width	∞	130.3	100.0	57.7	41.4	27.7	13.2	6.6
Image height	567.1	79.5	66.2	41.4	30.6	20.3	9.6	4.8

Lenses for S15D Modules with 5MP Image Sensor

Lenses with 5MP Image Sensor	L12	L23	L25	L38	L51	L76	L160	L320
Original image (image format 4:3)								
35 mm equiv.	12 mm	23 mm	25 mm	38 mm	51 mm	76 mm	160 mm	320 mm
True focal length	1.8 mm	3.6 mm	4 mm	6 mm	8 mm	12 mm	25 mm	50 mm
Aperture	2.0	1.8	1.8	1.8	1.8	1.8	1.8	2.5
Horizontal angle of view	180°	92°	82°	55°	40°	27°	13°	7°
Vertical angle of view	160°	68°	61°	41°	30°	20°	10°	5°
At 1 m distance								
Image width	∞	2.1	1.7	1.0	0.7	0.5	0.2	0.1
Image height	11.3	1.3	1.2	0.7	0.5	0.4	0.2	0.1
At 5 m distance								
Image width	∞	10.4	8.7	5.2	3.6	2.4	1.1	0.6
Image height	56.7	6.7	5.9	3.7	2.7	1.8	0.9	0.4
At 10 m distance								
Image width	∞	20.7	17.4	10.3	7.2	4.9	2.3	1.1
Image height	113.4	13.5	11.9	7.5	5.4	3.6	1.7	0.9
At 20 m distance								
Image width	∞	41.4	34.7	20.6	14.5	9.7	4.6	2.3
Image height	226.9	27.0	23.7	14.9	10.8	7.2	3.4	1.7
At 50 m distance								
Image width	∞	103.6	86.8	51.5	36.2	24.3	11.4	5.7
Image height	567.1	67.5	59.3	37.3	27.0	18.0	8.6	4.3

Types of Optical Sensor Modules



Sensor module
L10-L12



Sensor module
L20-L23 bis L135-L160



Sensor module
L270-L320



BlockFlexMount
L10-L12 to L270-L320



BlockFlexMount
CS-Mount (without lens)

1.2.3 S15D with Thermal Sensor Modules

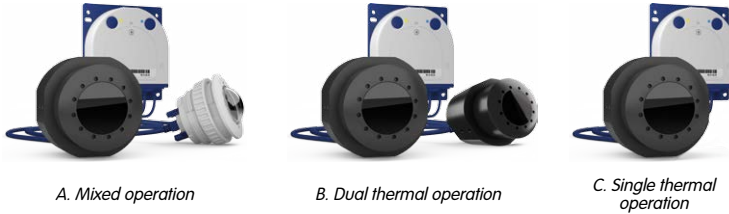

The following combinations of thermal sensor modules are possible for an S15D:

- A. **Mixed operation** (1 thermal sensor module, 1 optical sensor module): The advantages of an S15D with thermal sensor module and simultaneous daylight sensor lie in the combination of both images: brilliant 5-megapixel images during the day and in twilight hours and reliable motion detection at night.
- B. **Dual thermal operation** (2 thermal sensor modules): two thermal images of two different detection areas with only one camera.
- C. **Single thermal operation** (1 thermal sensor module): One thermal image, thermal sensor module flexibly installed.

Available Focal Lengths Thermal Sensor Module			
Example image			
Article number	MX-SM-Thermal-L43	MX-SM-Thermal-L65	MX-SM-Thermal-L135
Focal length (≅35 mm)	43 mm	65 mm	135 mm
Actual focal length	7.5 mm	13 mm	19 mm
Angle of view	45°	25°	17°

1.2.4 Camera Variants – Lenses, Hardware, Image Formats

Camera Model			
	S15D-SEC	S15M-SEC	S15M-SEC-Night
Lenses with 6MP/5MP Image Sensors			
L10-L12 Hemispheric	•	•	•
L20-L23 Super Wide-Angle	•	–	–
L22-L25 Super Wide-Angle	•	–	–
L32-L38 Wide-Angle	•	–	–
L43-L51 Wide-Angle	•	–	–
L65-L76 Tele	•	–	–
L135-L160 Tele	•	–	–
L270-L320 Tele	•	–	–
CSVario L24–54/L27–60 (BlockFlexMount only)	•	–	–
Image sensor 6MP/5MP	Color/BW (freely combinable)	Color	BW
Sensor sensitivity 6MP in lux at 1/60 s and 1 s	0.1 / 0.005 and 0.02 / 0.001	0.1 / 0.005	0.02 / 0.001
Sensor sensitivity 5MP in lux at 1/60 s and 1 s	0.25 / 0.013 and 0.05 / 0.0025	0.25 / 0.013	0.05 / 0.0025
Hardware Features			
IP protection class	IP65	IP65	IP65
Temp. Internal DVR (MB)	64	64	64
Internal DVR (MicroSD, SDXC, pre-installed)	•	•	•
Microphone (in sensor modules)/speaker	•/–	–/–	–/–
Passive infrared sensor (PIR)	–	–	–
Integrated temperature sensor	•	•	•
Shock detector	•	•	•
Power consumption in watts (typical)	< 5	< 4.5	< 4.5
Variable PoE class	2 – 3	2 – 3	2 – 3
Image Formats, Frame Rates and Image Storage			
Max. resolution (per sensor)	6MP (3072x2048) 5MP (2592x1944)	6MP (3072x2048) 5MP (2592x1944)	6MP (3072x2048) 5MP (2592x1944)
Max. frame rate (MxPEG, max. resolution)	6MP : 8 fps 5MP : 10 fps	6MP : 8 fps 5MP : 10 fps	6MP : 8 fps 5MP : 10 fps
CIF images with 4 GB MicroSD DVR	250,000	250,000	250,000
VGA images with 4 GB MicroSD DVR	125,000	125,000	125,000
MEGA images with 4 GB MicroSD DVR	40,000	40,000	40,000
QXGA images with 4 GB MicroSD DVR	20,000	20,000	20,000

1.2.5 Camera Variants – Software Features

Camera Model	 S15D-SEC	 S15M-SEC	 S15M-SEC-Night
General Features			
Digital zoom (continuous) with panning	•	•	•
Motion JPEG/MxPEG/H264 codecs	•/•/•	•/•/•	•/•/•
Programmable exposure ones	•	•	•
Snapshot rec. (pre-/post-alarm images)	50	50	50
Terabyte ring buffer storage (internal/network)	•	•	•
Continuous rec. with sound (0.2 to 30 fps)	•	•	•
Event recording with sound	•	•	•
Time and event control	•	•	•
Weekly schedules/holidays	•	•	•
Web functionality (FTP, email)	•	•	•
Playback/Quad and MultiView, bidirectional sound in browser	•	•	•
Logo generator, animated	•	•	•
Flexible event logic	•	•	•
Master/Slave arming	•	•	•
Several scheduled privacy zones	•	•	•
Customized voice messages	•	•	•
VoIP telephony (audio/video, alert)	•	•	•
Remote alarm notification (network msg.)	•	•	•
Signal inputs/outputs, RS232	Via MX-232-IO-Box		
Programming interface/HTTP API	•	•	•
Security features (HTTPS/SSL, IP-based access control, IEEE 802.1X network authentication)	•	•	•
Video Analysis			
Video Motion detector	•	•	•
MxAnalytics	–	–	–
MxActivitySensor	•	•	•
Video Management Software			
MxEasy, MxCC	•	•	•
MOBOTIX App	•	•	•

Free-of-charge download from www.mobotix.com or App Store

1.2.6 Technical Data

Technical Data S15	
Model variants (fitted with day or night sensors)	MX-S15M-SEC (day), MX-S15M-SEC-NIGHT (night), MX-S15D-SEC (any combination of day/night sensor modules)
Lens options	10 to 270 mm 35 mm, hor. angle of view 180° to 8° (6MP) 12 to 320 mm 35 mm, hor. angle of view 180° to 7° (5MP)
Sensitivity	Color sensor (6MP): 0.1 Lux at 1/60 s, 0.005 Lux at 1 s B&W sensor (6MP): 0.02 Lux at 1/60 s, 0.001 Lux at 1/1 s
Image sensors	1/1.8" CMOS, 6MP, Progressive Scan 1/2.5" CMOS, 5MP, Progressive Scan
Max. image resolution	Color: 3072x2048 (6MP), 5184x1944 (12MP) Black and white: 3072x2048 (6MP), 5184x1944 (12MP)
Image formats (per sensor)	3072x2048 (6MP), 2592x1944 (5MP), 2048x1536 (QXGA), 1920x1080 (Full HD), 1280x960 (MEGA), 1280x720 (HD), 1024x768, 800x600, 768x576 (D1-PAL), 704x576 (TV-PAL), 640x480, 384x288, 320x240, 160x120, custom image formats
Max. frame rate M-JPEG (live/recording)	VGA: 30 fps, MEGA: 15 fps, QXGA: 8 fps, 6MP: 4 fps Doppelbild: 12MP 2 fps, 10MP 3 fps
Max. frame rate MxPEG (live and recording including sound)	VGA: 30 fps, MEGA: 30 fps, QXGA: 20 fps, 6MP: 8 fps, 5MP: 10 fps, Dual image: 12MP 4 fps, 10MP 5 fps
Image compression	MxPEG, M-JPEG, JPEG, H.264
Internal DVR	MicroSD card pre-installed (SDXC)
External video ring buffer	Directly on NAS and computer/server without additional recording software
Software (included)	MxEasy video management software, MxControlCenter control center software, MOBOTIX App for iOS devices with iOS 5.0 and higher
Image processing	Backlight compensation, automatic white balance, image distortion correction, panorama correction, Video Motion detection, MxActivitySensor,
Virtual PTZ	Digital pan/tilt/zoom, continuous 8X zoom
Alarm/events	Video Motion detection, MxActivitySensor, external signal, temperature sensor, PIR, microphone, shock detector, notification over e-mail, FTP, IP telephony (VoIP, SIP), visual/ acoustic alarm, pre- and post-alarm images
Microphone and speaker	S15D: Microphone integrated into optical and BlockFlexMount sensor modules; external microphone and speaker can be connected, S15M: external microphone and speaker can be connected
Audio features	Lip-synchronous audio, two-way communication, audio recording

Functionality depends on
camera variant
(see Section 1.2.5,
«Camera Variants -
Software Features»)

Technical Data S15	
Interfaces	10/100 Ethernet (patch or installation cable), MiniUSB, MxBus; inputs and outputs and RS232 via accessories; external microphone, external speaker
Video telephony	VoIP/SIP, two-way communication, remote controlling with key code, event notification
Security	User/group management, HTTPS/SSL, IP address filter, IEEE 802.1x, intrusion detection, digital image signature
Certifications	EMC (EN 55022, CISPR 22, EN 55024, EN 61000-6-1/2, FCC part15B, CFR 47, AS/NZS 3548)
Power supply	Year-round Power-over-Ethernet (IEEE 802.3af); variable PoE class, approx. 5 W (S15D)/4.5 W (S15M)
Power consumption	S15D: Typical < 4.5 W with 1 sensor module, < 5 W with 2 sensor modules S15M: Typical < 4.5 W
Operating conditions	IP65, -30 to +60 °C/-22 to +140 °F
Dimensions/weight S15M	W x H x D: 115 x 130 x 40 mm (installation dimensions); weight: approx. 457 g (including lens)
Dimensions/weight S15D	W x H x D: 115 x 130 x 33 mm; weight: approx. 444 g (without sensor modules, see below)
Dimensions/weights Sensor modules	L10-L12: diam. x D: 43 x 45 mm (installation dim.), weight: 85 g L22-L25, L43-L51: diam. x D: 43 x 57 mm (installation dim.), weight: 111 g L32-L35, L65-L76, L135-L160: diam. x D: 43 x 60 mm (installation dim.), weight: 122 g L270-L320: diam. x D: 43 x 60 mm (installation dim.), weight: 160 g
Weight of 2 m connection cable (per sensor module, S15D only)	about 68 g
Delivered parts	Housing (high-resistance composite, PBT), white, blue anodized aluminum base plate, shock-resistant dome for sensor module L10-L12, coated glass pane for all other sensor modules, mounting parts, Allen wrench, 50 cm patch cable, manual, software, MicroSD card pre-installed (SDXC)



Technical Specifications Thermal Sensor Module	
Lens Options	L43 (45°), L65 (25°), L135 (17°) (horizontal angle of view)
Sensitivity	NETD typ. 50 mK (equals 0.05°C), <79 mK
Image Sensor	Uncooled microbolometer, 336x252 pixels, spectral range 7.5 to 13.5 µm
Temperature Measurement Range	-40 to +550 °C/-40 to 1.022 °F (temperature of the displayable objects)
Max. Image Size	Can be scaled up to 3072x2048 (6MP), dual images are automatically scaled to size of the optical sensor module
Max. Frame Rate	9 fps (when displaying an optical sensor module and a thermal sensor module, the overall frame rate of the camera is reduced to 9 fps)
Software Features	Off-color/black & white image display, mirrored image, obscured image areas, vPTZ (virtual pan/tilt/zoom), text and logo display, display of event/action symbols, meter display (bar chart or diagram), temperature control windows
Power Consumption	Typ. 1.5 W per Thermal Sensor Module
Operating Conditions	IP66 (DIN EN 60529) -30 to +60 °C/-22 to +140 °F (DIN EN 50155)
Dimensions	Total length: 78 mm, max. Ø: 63 mm
Materials	Module housing: Aluminum, black anodized; Pressure plate: Stainless steel V2A
Weight	< 330 g (one Thermal Sensor Module without sensor cable)

Technical Data S15D with Thermal Sensor Module	
Image Formats (per sensor)	Standard formats like Full HD, VGA, etc. up to 3072x2048 (5MP) and custom formats
Alarm/Events	Video Motion detection, MxActivitySensor, external signals, shock detector, notification via e-mail, FTP, pre- and post-alarm images
Operating Conditions	IP65 (DIN EN 60529) -30 to +60 °C/-22 to +140 °F (DIN EN 50155)
Power Consumption	Depending on sensor modules used: <ul style="list-style-type: none"> • 1 thermal, 1 optical: typ. 6.5 W (briefly up to 7.5 W possible) • 2 thermal: typ. 7 W (briefly up to 8 W possible) • 1 thermal: typ. 5.5 W (briefly up to 6.5 W possible)
Max. Power Consumption of Attached Extension Modules	USB only: ≤ 1 W MxBus only: ≤ 1 W USB and MxBus: ≤ 2 W
Power Supply	Power-over-Ethernet (IEEE 802.3af); PoE Class 3 required

MOBOTIX S15D with 2 MX-SM-Thermal



MOBOTIX S15D with 1 MX-SM-Thermal, 1 MX-SM-D12



1.3 Delivered Parts and Dimensions

1.3.1 S15D Core (Base Module)

On www.mobotix.com go to **Products > S15 FlexMount** and open the basket. It contains a **Product Configurator**. Use this to order the required parts in any of the available colors.

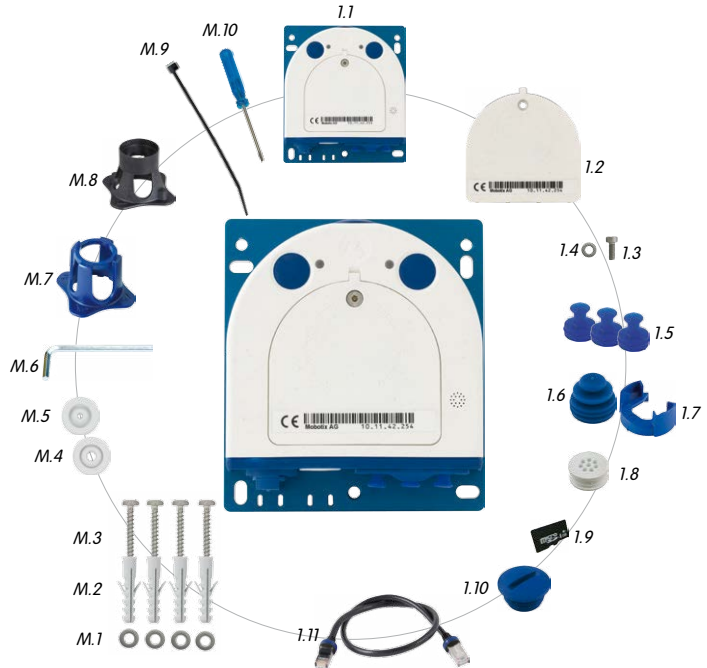

Item	Number	Part Name
1.1	1	S15D Core (base module with base plate)
1.2	1	Housing cover for S15D (installed)
1.3	1	Stainless steel flat-head Allen screw M4x8 (installed)
1.4	1	Washer (installed)
1.5	3	Sealing plug, blue, small (sensor modules, USB, inserted)
1.6	1	Sealing plug, blue, large (Ethernet patch cable, installed)
1.7	1	Cable retainer with bayonet catch (Ethernet patch cable, installed)
1.8	1	Single wire plug, white (Ethernet installation cable, microphone, speaker, MxBus; installed)
1.9	1	MicroSD card pre-installed (SDXC)
1.10	1	Rotary plug, SD card, blue (installed)
1.11	1	Ethernet patch cable, 50 cm, with seal

Mounting Supplies

Item	Number	Part Name
M.1	4	Stainless steel washers, diam. 4.3 mm
M.2	4	6-mm screw anchors
M.3	4	Stainless steel wood screws 4x40 mm with PZ 2 driver bit
M.4	2	Cable plug, 5–7 mm, white (Ethernet installation cable)
M.5	1	Cable plug, 3–5 mm, white (Ethernet installation cable)
M.6	1	Allen wrench 2.5 mm
M.7	1	Lens wrench (lens, dome)
M.8	1	Module wrench (sensor module, glass/filter insert)
M.9	1	Cable tie (Ethernet installation cable, microphone, speaker, MxBus)
M.10	1	Screwdriver (screw clamps)

S15D Core (Base Module) Design

The base module of the MOBOTIX S15D consists of a housing, a housing cover and a base plate for attaching the camera.

LED default settings:

- 1 Power (on), Error (flashes)
- 2 Recording (flashes)

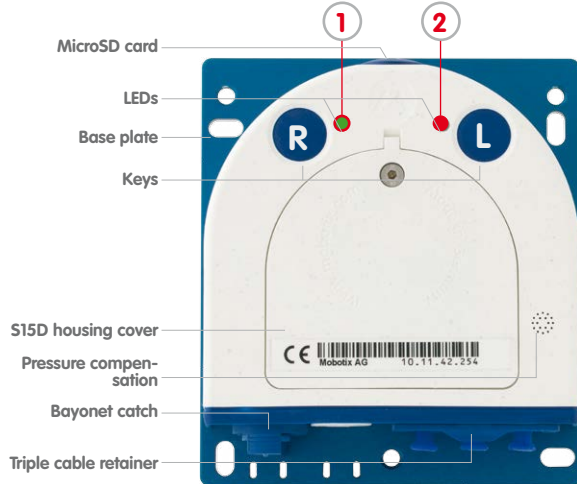

Externally-Accessible Connections on the S15D

The MOBOTIX S15D provides the following external connections that can be accessed once the cover plugs are removed:



Special USB cable for external devices (USB stick, USB hard drive) available as an accessory

Cables with straight plugs can be used for the S15 on the camera only

For external connections shown above always use the corresponding MOBOTIX cables with seal:

- Ethernet patch cable: **MX-OPT-CBL-LAN-1/2/5/10**
- MiniUSB (straight/straight): **MX-CBL-MU-STR-05/2/5**
- MiniUSB (straight/angled): **MX-CBL-MU-EN-STR-05/2/5**
- MiniUSB to USB-A (straight to USB port): **MX-CBL-MU-STR-AB-05/2/5**
- Sensor modules: **MX-FLEX-OPT-CBL-05/1/2**

Internally-Accessible Connections on the S15D

The MOBOTIX S15D provides the following internal connections that can be accessed once the cover plugs and housing cover are removed:

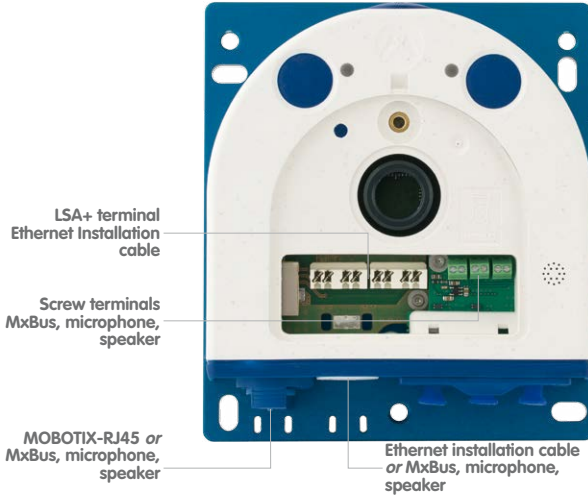

Before laying the Ethernet installation cable, remove the bayonet catch and replace the Ethernet patch cable plug with either one of the additional plugs (M.4/5) or the single wire plug (1.8), depending on the cable used.

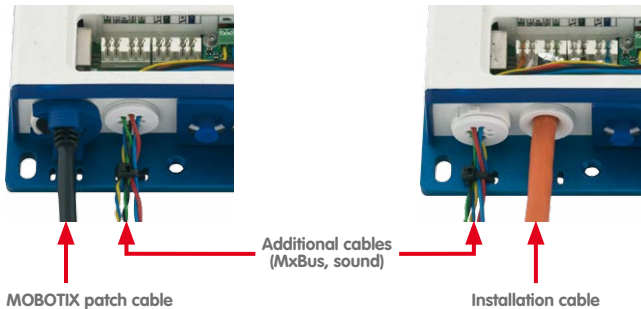

The drilling templates can be found at the end of the manual

Always print or copy drilling template in their original size

S15D Core (Base Module) Dimensions

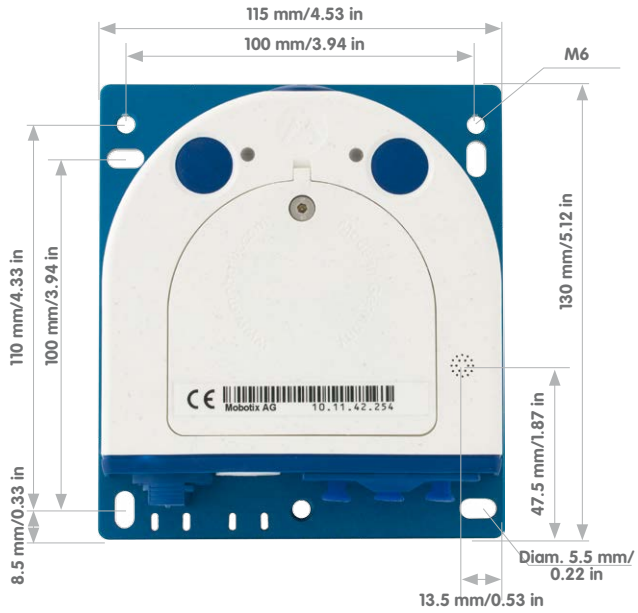

Attaching the Base Module

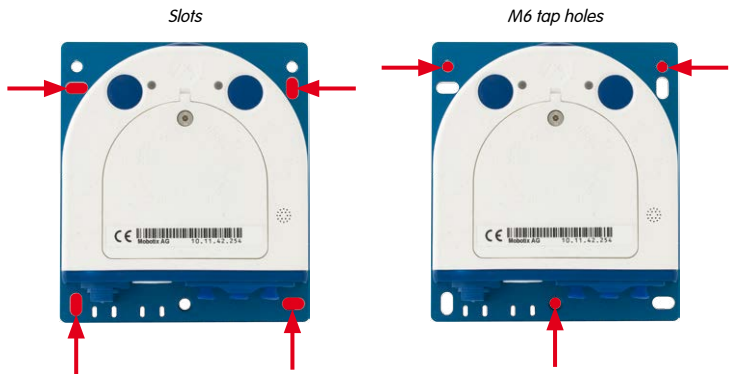



*6MP image sensor: first value (L10)

5MP image sensor: second value (L12)

Sensor module including status LEDs and microphone

1.3.2 Sensor Modules L10-L12*



Item	Number	Part Name
2.1	1	Sensor module with affixed washer
2.2	1	MOBOTIX lens L10-L12 (installed)
2.3	1	Dome (installed)
2.4	1	Cable retainer with bayonet catch (installed)
2.5	1	Sealing plug, blue, small (installed)
2.6	1	Nut (plastic)

Front View

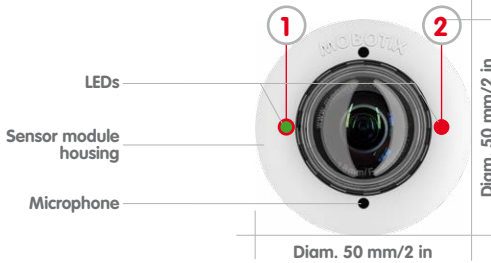

LED default settings:

- 1 Power (on), Error (flashes)
- 2 Recording (flashes)

Rear View

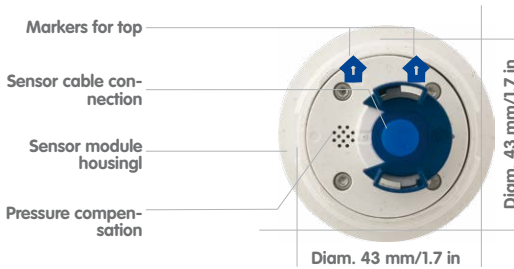

Top = top border of image (North)

Side View

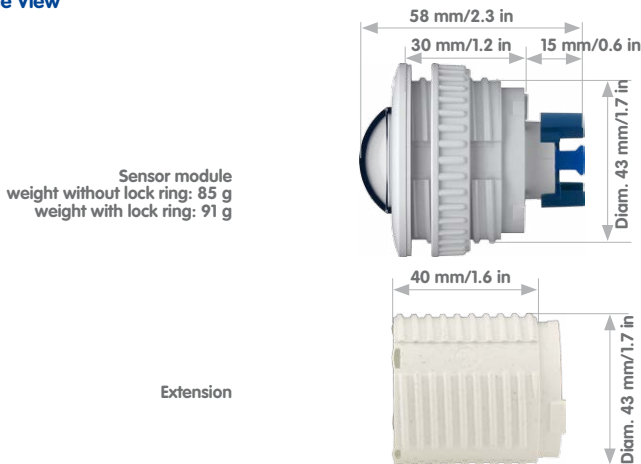

*6MP image sensor: first value

5MP image sensor: second value

Sensor module including status LEDs and microphone

1.3.3 Sensor Modules L20-L23, L22-L25, L32-L38, L43-L51, L65-L76, L135-L160*



Item	Number	Part Name
3.1	1	Sensor module with affixed washer
3.2	1	MOBOTIX lens L20-L23/L22-L25/L32-L38/L43-L51/L65-L76/L135-L160 (installed)
3.3	1	Protective glass insert with coated glass (installed)
3.4	1	Cable retainer with bayonet catch (installed)
3.5	1	Sealing plug, blue, small (installed)
3.6	1	Nut (plastic)

Front View

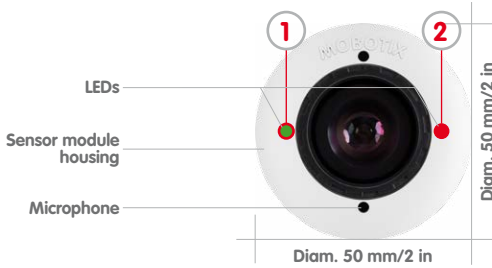

LED default settings:

- 1 Power (on), Error (flashes)
- 2 Recording (flashes)

Rear View

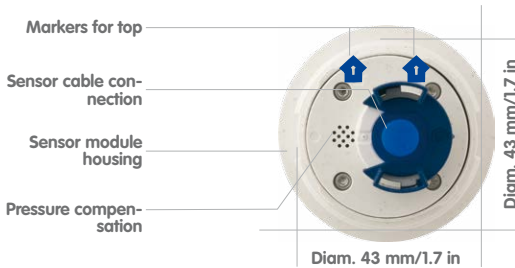

Top = top border of image (North)

Side View

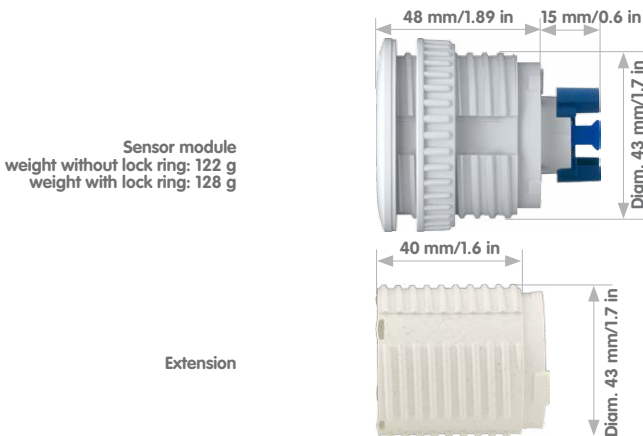

*6MP image sensor: first value

5MP image sensor: second value

Sensor module

1.3.4 Sensor Modules L270-L320*



Item	Number	Part Name
4.1	1	Sensor module with affixed washer
4.2	1	MOBOTIX lens L270-L320 (installed)
4.3	1	Protective lens cover (installed)
4.4	1	Cable retainer with bayonet catch (installed)
4.5	1	Sealing plug, blue, small (installed)
4.6	1	Nut (plastic)

Front View



Rear View

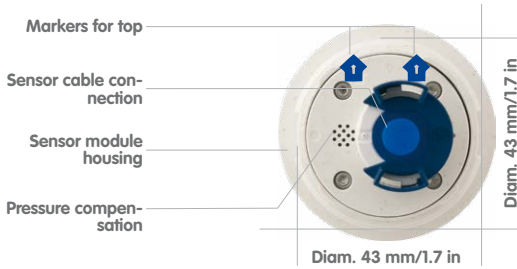

Top = top border of image (North)

Side View

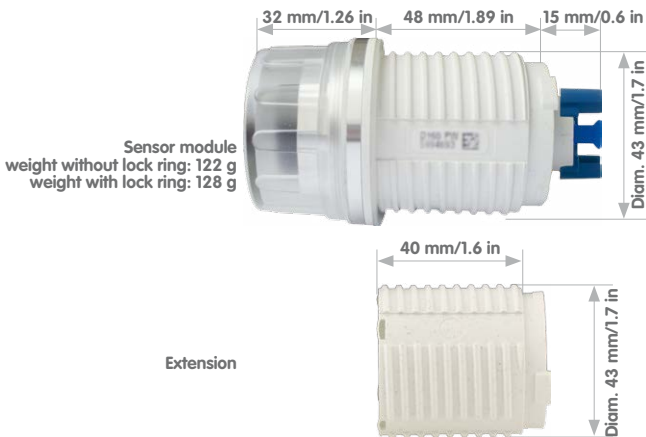

*6MP image sensor: first value

5MP image sensor: second value

1.3.5 BlockFlexMounts L10-L12, L20-L23, L22-L25, L32-L38, L43-L51, L65-L76, L135-L160, L270-L320*

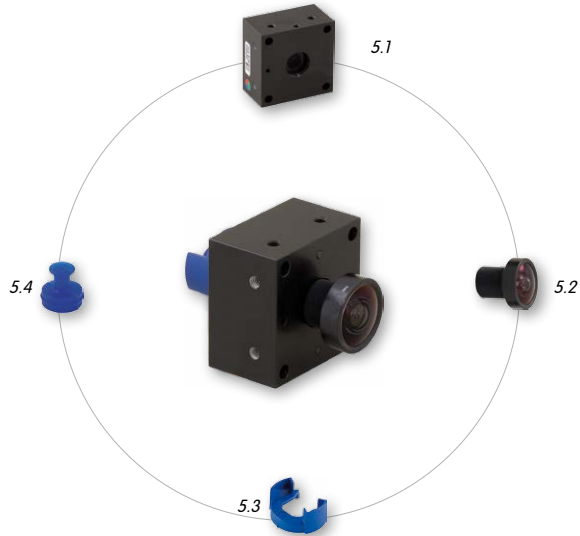

BlockFlexMount including status LEDs and microphone

Item	Count	Part Name
5.1	1	Housing MX-BFM-MX, black anodized
5.2	1	MOBOTIX lens L10 to L270 (6MP), L12 to L320 (5MP) (installed)
5.3	1	Cable lock with bayonet catch (installed)
5.4	1	Sealing plug blue, small (installed)

Front View

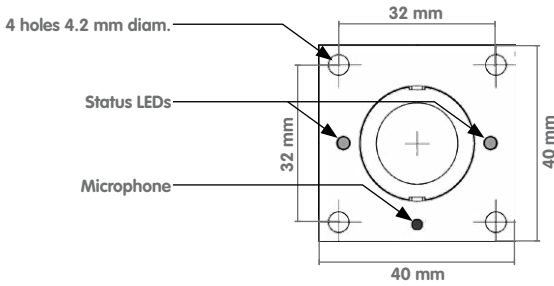

Back View

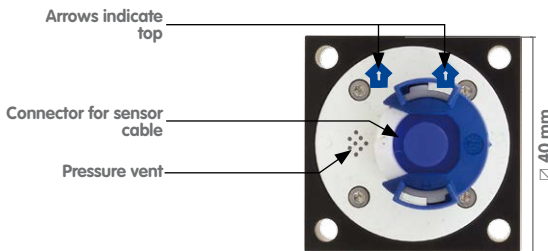

Top = upper image border (North direction)

Side View

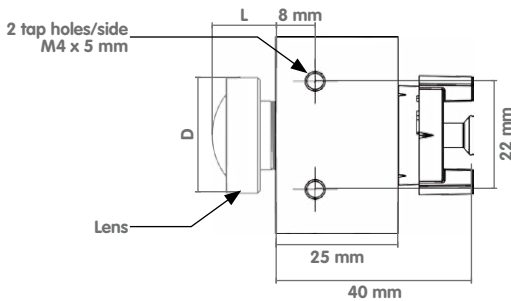

Measurements dep. on Lens		
Lens	D (mm)	L (mm)
L10-L12	23.5	13.0
L20-L213	22.0	17.0
L22-L25	22.0	17.0
L32-L38	22.0	18.2
L43-L51	20.0	11.7
L65-L76	22.0	17.5
L135-L160	22.3	17.8
L270-L320	27.0	42.5

1.3.6 BlockFlexMount CS Mount

BlockFlexMount
including microphone

*6MP image sensor: first
value (L24-54)
5MP image sensor:
second value (L27-60)



Item	Count	Part Name
6.1	1	Housing MX-BFM-CS, black anodized
6.2	2	Spacer disc 0.25 mm thick
6.3	1	Cable lock with bayonet catch (installed)
6.4	1	Sealing plug blue, small (installed)

Front View

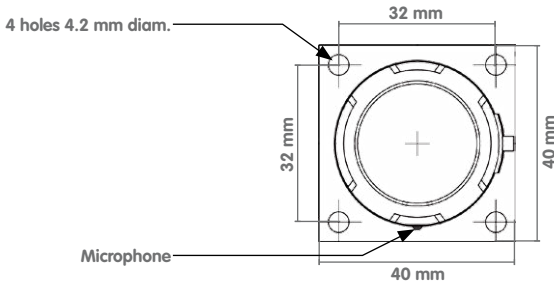

Back View

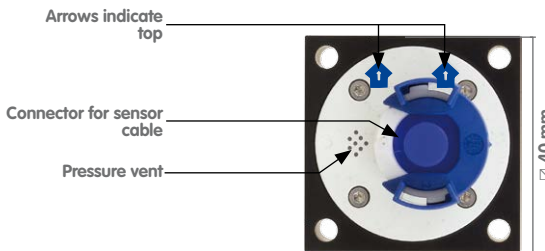

Top = upper image border (North direction)

Top View

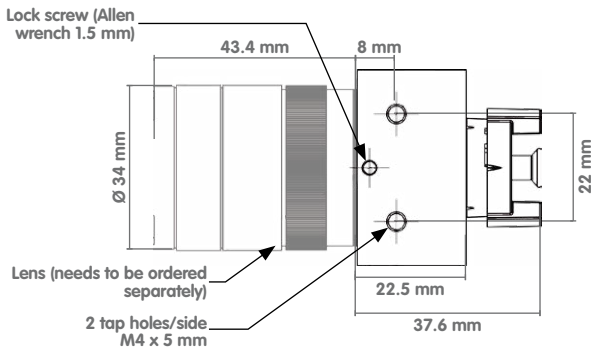

1.3.7 Thermal Sensor Modules L43, L65, L135

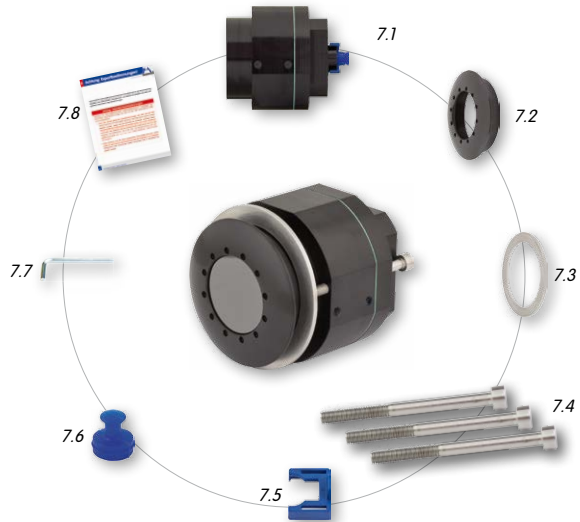

Item	Count	Part Name
7.1	1	Housing MX-SM-Thermal-L43/65/135, black anodized
7.2	1	Front plate aluminum, black anodized (installed)
7.3	1	Pressure plate Ø 63 mm, stainless steel (installed)
7.4	3	Cylinder head screws M4x50 mm, stainless steel (installed)
7.5	1	Cable lock, blue (installed)
7.6	1	Sealing plug blue, small (installed)
7.7	1	Allen wrench 3 mm
7.8	1	Special export regulations German/English

Front View

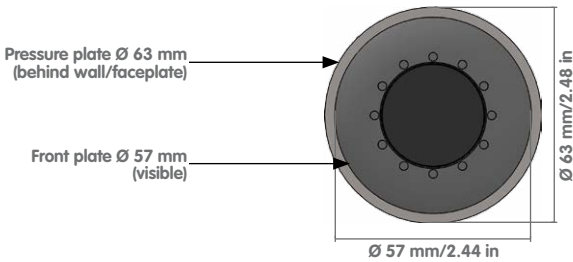

Back View

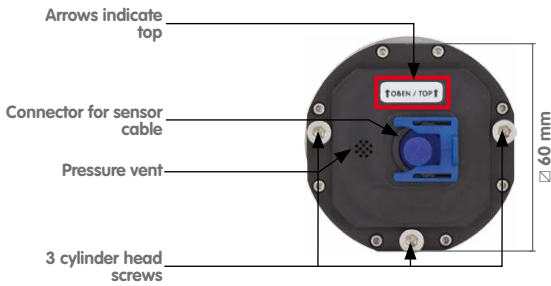

Top = upper image border (North direction)

Side View

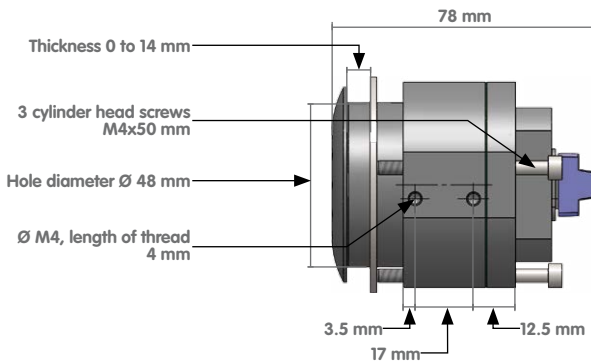

On www.mobotix.com got to **Products > S15 FlexMount** and open the basket. It contains the **Product Configurator**. Use this to order the required parts in any of the available colors.

1.3.8 S15M



Item	Number	Part Name
8.1	1	Camera housing (with base plate)
8.2	1	Lens L10 (6MP)/L12 (5MP) (installed)
8.3	1	Dome (installed)
8.4	1	Housing cover for S15M (installed)
8.5	3	Stainless steel flat-head Allen screw M4x8 (installed)
8.6	1	Washer
8.7	1	Sealing plug, blue, small (sensor modules, USB, inserted)
8.8	1	Sealing plug, blue, large (Ethernet patch cable, installed)
8.9	1	Cable retainer with bayonet catch (Ethernet patch cable, installed)
8.10	1	Single wire plug, white (Ethernet installation cable, microphone, speaker, MxBus)
8.11	1	MicroSD card pre-installed (SDXC)
8.12	1	Rotary plug, SD card, blue (installed)
8.13	1	Ethernet patch cable, 50 cm, with seal

Mounting Supplies

Item	Number	Part Name
M.1	4	Stainless steel washers, diam. 4.3 mm
M.2	4	6-mm screw anchors
M.3	4	Stainless steel wood screws 4x40 mm with PZ 2 driver bit
M.4	2	Cable plug, 5-7 mm, white (Ethernet installation cable)
M.5	1	Cable plug, 3-5 mm, white (Ethernet installation cable)
M.6	1	Allen wrench 2.5 mm
M.7	1	Lens wrench (lens, dome)
M.9	1	Cable tie (Ethernet installation cable, microphone, speaker, MxBus)
M.10	1	Screwdriver (screw clamps)

S15M Camera Housing

The MOBOTIX S15M consists of a base plate for attaching the camera, a housing with built-in lens, and a housing cover.

LED default settings:

- 1 Power (on), Error (flashes)
- 2 Recording (flashes)

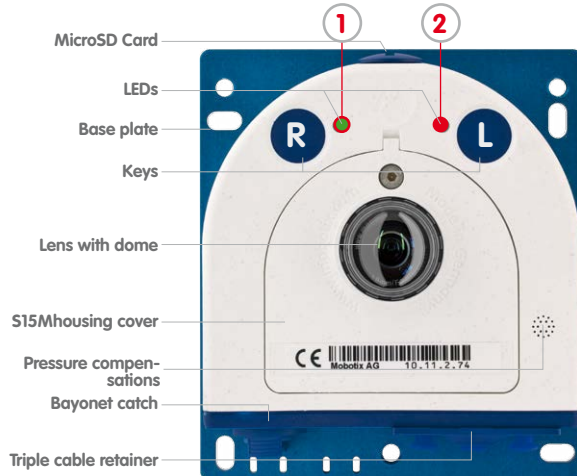

Externally-Accessible Connections on the S15M

The MOBOTIX S15M provides the following external connections that can be accessed once the cover plugs are removed:



Cables with straight plugs can be used for the S15 on the camera only

The external connections may only be used with the designated sealed MOBOTIX cables (**MX-OPT-CBL-LAN-1/2/5/10** Ethernet patch cable and **MX-MX-CBL_MU_STR-5** MiniUSB cable).

Internally-Accessible Connections on the S15M

The MOBOTIX S15M provides the following internal connections that can be accessed once the cover plugs and housing cover are removed:

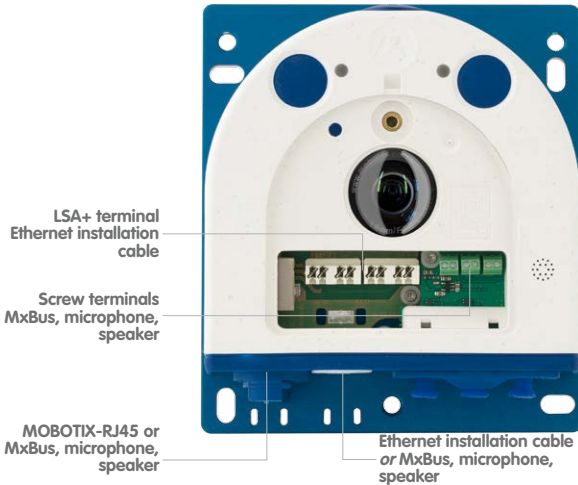

Before laying the Ethernet installation cable, remove the bayonet catch and replace the Ethernet patch cable plug with either one of the additional plugs (M.4/5) or the single wire plug (2.10), depending on the cable used.

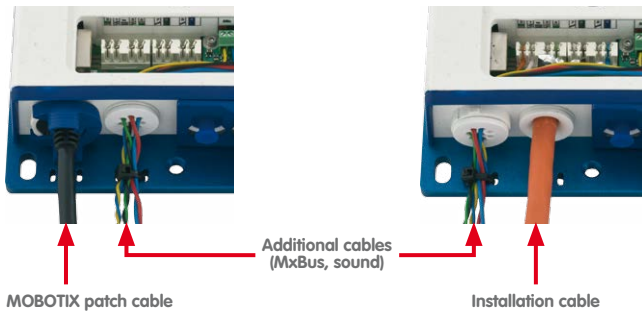

The drilling templates can be found at the end of the manual

Always print or copy drilling template in their original size

Dimensions S15M

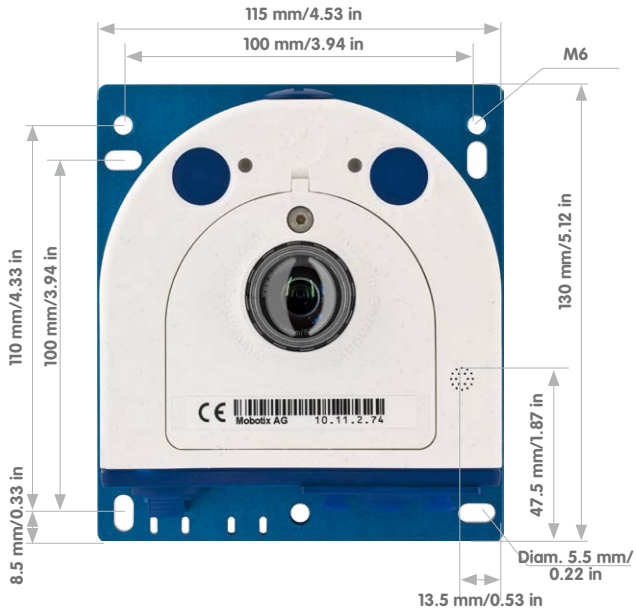

Attaching the Camera Housing

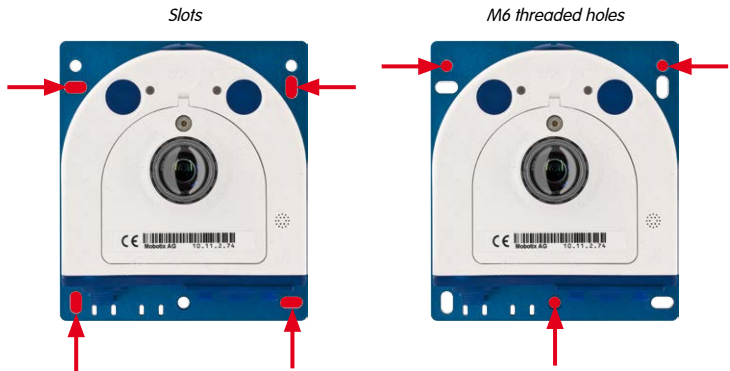



1.4 Available Accessories

1.4.1 Extension for Sensor Module

Order No.: MX-S15-OPT-MK-EX

Each of these extensions increases the installation depth by 40 mm. They can be mounted directly onto the sensor modules themselves or onto existing extensions.

1.4.2 Ceiling/Wall Installation Set

Order No.: MX-S15-OPT-MK-CW

This set contains everything that is needed to attach a sensor module to a ceiling or wall using 15° wedges: One extension (MX-S15-OPT-MK-EX), two 15° wedges (white, black), two wedge washers and an additional nut.

Out of the colored wedges, use the most suitably-colored wedge for the visible area and the other one for inserting on the rear.



1.4.3 Connection Cable for Sensor Module

Order No.: MX-FLEX-OPT-CBL-05/1/2/3

This cable, which is up to three meters long (three meters only allowed for 6MP image sensors), connects one sensor module to the S15D. The seals integrated into the cable combine with the bayonet catch on the sensor module and the sealed port of the S15D to provide IP65-compliant weatherproofing. Also included are two hinged ferrites that are attached at a distance of 10 cm to the base module and the sensor module after installation.



Do not bend the sensor cables

Cables with straight plugs can be used for the S15 on the camera only

1.4.4 MiniUSB Cable to MiniUSB (Straight/Straight or Straight/Angled)

Order No.: MX-CBL-MU-STR-05/2/5 (Straight/Straight)

Order No.: MX-CBL-MU-EN-STR-05/2/5 (Straight/Angled)

With this cable, which is up to five meters long, MOBOTIX add-on modules (MX-232-IO-Box, ExtIO, CamIO) can be connected directly to the S15.



1.4.5 MiniUSB Cable to USB a Socket

Order No.: MX-CBL-MU-STR-AB-05/2/5

USB-based storage media (for example, USB hard drives) can be connected directly to the S15 with this cable, which is up to five meters long.



1.4.6 Ethernet Patch Cable for Bayonet Catch

Order No.: MX-OPT-CBL-LAN-1/2/5/10
(length 1 m/2 m/5 m/10 m)

The MOBOTIX-developed special cable can be installed in a waterproof manner and has an integrated sealing gasket. Every S15 ships with a 0.5-m-long cable as standard, which can be exchanged for a patch cable up to 10 m in length.



1.4.7 NPA-PoE-Set

Order No.: MX-NPA-PoE-EU u. MX-NPA-PoE-INT (Version EU and Version INT)
Order No.: MX-CBL-NPA-BAT-2 (battery cable for mobile voltage sources)

This is a multifunctional PoE injector according to the IEEE 802.3af standard – with three connectors (for network, camera/PoE device, PC), universal power supply unit with interchangeable adapter plugs and crossover function. The NPA-PoE-Set connects and remotely supplies an S15 with power via an Ethernet cable up to 100 m in length. The blue adapter can also be connected to mobile voltage sources from 12 to 42 V DC by means of an additionally available battery cable. The “EU” version of the NPA-PoE-Set is supplied as standard with a European adapter, while the “INT” version includes four adapters (EU, USA, UK, AUS).



1.4.8 MX-Overvoltage-Protection-Box

Order no.: MX-Overvoltage-Protection-Box-RJ45
Order no.: MX-Overvoltage-Protection-Box-LSA

Weatherproof network connector (protection class IP65, -30 to +60°C/-22 to 140°F) **with surge protection of up to 4 kV for MOBOTIX IP cameras**, ideal for replacing the MX-Patch-Box. At the same time, the MX-Overvoltage-Protection-Box provides a weatherproof



connection of a camera's patch cable to a network patch cable (-**RJ45** variant) or a network installation cable (-**LSA** variant).

1.4.9 MX-NPA-Box

Order No.: MX-OPT-NPA1-EXT

The MX-NPA-Box is a weatherproof PoE injector conforming to the IEEE 802.3af standard and is designed to connect to a MOBOTIX camera external voltage sources (12 to 57 V DC).

The MX-NPA-Box is equipped with the weatherproof and extremely compact exterior housing of the Patch-Box (protection class IP65, -30 to +60°C/-22 to +140°F, which means it can also be installed in the space of the Outdoor Wall Mount. MX-NPA-Box interfaces: Camera via patch cable, Ethernet via LSA+ and external power supply (12 to 57 V DC is possible).



1.4.10 MX-GPS-Box

Order No.: MX-OPT-GPS1-EXT

This box primarily serves as a high-precision time source for systems without an Internet connection. The IT and Secure models additionally provide triggering of GPS-based events (reaching or moving away from a specified position; exceeding or not reaching a specified speed). The MX-GPS-Box can be connected as an add-on module to all MOBOTIX cameras with an MxBus interface.



The MX-GPS-Box has the same compact exterior housing as the MX-Patch-Box and the MX-NPA-Box (IP65 protection class, -30 to +60°C/-22 to +120°F. Note that this box should not be installed below other wall-mounted units. It should be installed on the exterior of the building with a large section of open sky above it, which ensures the best possible reception from GPS satellites and thereby the highest possible accuracy of the received GPS data. The maximum length of the MxBus cable (diameter: 0.8 mm) is 50 m.

1.4.11 MX-232-IO-Box

Order No.: MX-OPT-RS1-EXT

This box provides the signal inputs and outputs as well as the RS232 (serial) interface. It replaces the connections that were handled on the older camera models via a D-Sub 15-HD connector. The MX-232-IO-Box can be connected as an add-on module to all MOBOTIX cameras with an MxBus or USB interface. The maximum length of the MxBus cable (diameter: 0.8 mm) is 50 m. If the MiniUSB connection is used, the maximum cable length is 5 m.



1.4.12 ExtIO Expansion Module

Order No.: MX-ExtIO

The device, which is suitable both for on-wall and in-wall installations, contains a powerful speaker, microphone, infrared motion sensor, ambient temperature sensor, two input and two output contacts and two illuminated keys. It is ideal for door communication, elevators, access control systems, etc. The ExtIO is suitable for use as direct connection to the S15 via a MiniUSB cable (max. 5 m), which can be ordered separately, or as a network connection via the PoE switch.



1.4.13 Mx2wire+ Media Converter

Order No.: MX-2wirePlus-Set-PW

The Mx2wire+ system allows an Ethernet network with PoE to be set up via two-wire cables, which saves users from having to lay several hundred meters of Ethernet cable. For example, an existing two-wire cable of an analog video camera can be reused to connect a high-resolution and modern IP network camera. Mx2wire+ is delivered in the standard wall outlet frame in different designs; however, it can also be used with the available on-wall socket that is included.



1.4.14 AudioMount

Order no.: MX-FLEX-OPT-AM-BL

The AudioMount is an installation option for the S15M with a self-adhesive front that can be attached to the back of thin and smooth surfaces (stainless steel plate, mailbox, etc.). The AudioMount has a pre-installed speaker and microphone, thus ensuring full intercom capabilities of the camera. Together with the AudioMount and additional MOBOTIX accessories, you can easily set up the S15M FlexMount as a hemispherical door station (note that the camera needs to run a firmware 4.1.9 or higher).

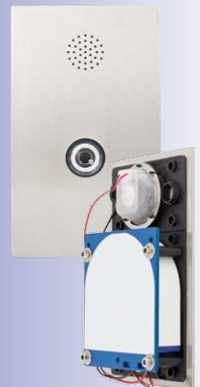

1.4.15 DualMount

Order no.: MX-OPT-FM-PW

The DualMount provides for installing two sensor modules side-by-side with parallel lines of sight, making it the ideal installation solution for the S15D in day/night settings (both lenses are monitoring the same area). The DualMount is quickly and easily installed, it can be used with all available sensor modules and the lenses are tilted downwards by 25 degrees. In outdoor applications, this installation option can be installed without drawing much attention (beneath eaves, protruding construction elements, bridges, etc.).



1.4.16 SurroundMount

Order no.: MX-OPT-SM-PW

When dealing with long and narrow spaces (buses, airplanes, trains, etc.), this installation option allows positioning two hemispherical sensor modules pointing in opposite directions. The resulting dual hemispheric image with up to 10 megapixels displays a much higher degree of detail than a camera with only one hemispheric lens. To better support these types of installation, MOBOTIX offers the SurroundMount installation option for the S15D. Since both sensor modules are tilted downwards by 25 degrees, the resulting images cover the entire area without any blind spots.



Note that you can use the SurroundMount only with L10-L12, L22-L25 and L43-L51 sensor modules (day or night variants).

1.4.17 HaloMount

Order no.: MX-HALO-EXT-CM/CO/NG/PW/SW

The HaloMount is the perfect installation option to install sensor modules in rooms with in-ceiling lights. Using the same type of fixtures as in-ceiling lights (QR-CBC/MR 16 LED Sharp Array 4/6 W), this mount comes in five different colors (matt chrome, chrome, brushed Nickel, white, black). Since the inner ring can be tilted by up to 20 degrees, you can point the sensor module (and thus, the center of the image) to the center of the area that is to be monitored.

The HaloMount has not been designed to be used in outdoor applications. Materials: Steel, inner ring brass; surface powder-coated or galvanized; installation diameter: 68 mm/2.7 in.



1.4.18 SpeakerMount

Order no.: MX-HALO-SP-PW/CM

The SpeakerMount, available from MOBOTIX in white or matt chrome, is an external speaker that can be directly connected to the S15D/S15M (no additional power supply required). The high-quality speaker is especially suitable for S15 cameras. The speaker is pre-installed in the 20-degree-tilting mechanism of the HaloMount and is fitted in the same way in fake ceilings and walls. The SpeakerMount has not been designed to be used in outdoor applications. Temperature range: 0 to +60°C/32 to 140°F; protection class: IP20; nominal/music output: 3/4 W; impedance: 8 Ohms; material of the speaker: metal with perforated steel cover; connection type: two-wire strand with luster terminal; installation diameter: 68 mm/2.7 in.



1.4.19 PTMount

Order no.: MX-PTMount-OPT-PW

MOBOTIX offers the high-quality, weatherproof PTMount, an attractive, compact, discreet, and dome-shaped accessory mount that holds a single sensor module and is adjustable in three directions. The maximum flexibility for adjusting the modules means that you can always find the right position. When mounted to a wall, for example, the mount enables you to compensate for sideway tilt and to re-align the image horizon horizontally to record the best possible image of the surveillance area.



1.4.20 Sealing Ring as Dome Replacement for Sensor Modules L10-L12

Order no.: MX-OPT-Ring-L10-L12-PW/BL

For special scenarios with hemispheric sensor modules, e.g., if light entering from the side creates reflections within the dome, you can use the sealing ring instead of the dome (see also Section 3.3.3, «Replacing the Dome Against the Sealing Ring (Only Sensor Modules L10-L12)»). **In order to avoid burns by the hot lens, the dome must not be removed if the sensor module is within the reach of persons!**



1.4.21 Other Accessories

Since the range of accessories for the MOBOTIX system keeps growing, you should visit the MOBOTIX website www.mobotix.com in the **Products > Accessories** section to see the entire list of available accessories.

THE MOBOTIX INFORMATION CHANNELS



Support on the MOBOTIX Website
www.mobotix.com/other/Support



The MOBOTIX Video Tutorials
www.mobotix.com/other/Support/Tutorials



Seminars on MOBOTIX Campus
www.mobotix.com/other/Partners/Seminars



The MOBOTIX YouTube Channel
www.youtube.com/MOBOTIXAG



1.5 MOBOTIX Software

1.5.1 Integrated Camera Software (Firmware)

MOBOTIX cameras and connected MxBus modules operate with built-in firmware whose functions are accessed by the MOBOTIX **MxControlCenter**, **MxEasy** remote stations and **MOBOTIX App**.

The S15 models therefore also feature a variety of functions that are integrated in the firmware: from motion detection and long-term storage right through to alarm notification via video IP telephony. The virtual PTZ functions allow you to continuously zoom into or out of a MOBOTIX camera image using either the mouse wheel or a joystick.

When recording image or video sequences, you can choose to store either the section of the live image that is visible or the full sensor image (full image storage). This also allows you to examine parts of an image or video that had not been visible in the live image section on display at the time of the recording.

Unlike in the camera systems from other manufacturers, there is no need to buy an install additional software on your computer thanks to the MOBOTIX firmware that can be accessed directly in a web browser via the camera IP address. Instead of using a web browser, you can also download the free MxControlCenter or MxEasy video management software from the MOBOTIX website (www.mobotix.com > **Support**) to quickly display multiple cameras on one monitor or on an entire video wall, switch alarms with sound or conveniently search for an event. The **MOBOTIX App** for iOS devices (iPhone, iPad, iPod mini, iPod touch, iOS version 5.0 and higher) is also available free of charge from the **App Store** for your mobile applications.

Download free of charge
from www.mobotix.com

No license fees
Free updates

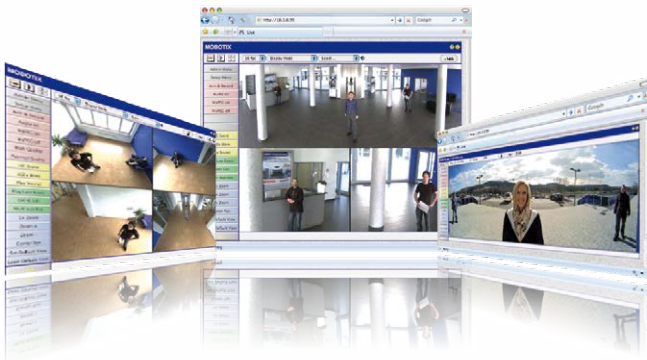



Several hundred cameras can be managed on a standard computer

Download free of charge from www.mobotix.com

No license fees
Free updates

1.5.2 MxControlCenter

The MxControlCenter video management software can be used to combine any number of cameras at any locations into a well-structured and powerful video security system with centralized or local access-protected operation and analysis.

The state-of-the-art software, specifically tailored to support high-resolution MOBOTIX network cameras, provides a user-friendly user interface and camera image display, convenient video search functions, effective alarm handling, automatic camera integration, video storage on file servers as well as useful configuration and update wizards.

MxControlCenter – Professional Video Management

- Proven worldwide in the most demanding video applications thousands of times over
- Unlimited number of users and cameras
- No license fees
- Individual user interface, adaptable to each individual user
- Simplest installation and complete use on any standard PC
- Convenient layout editor for integrating real building plans
- Integration of conventional network and analog cameras as well
- For Microsoft Windows



1.5.3 MxEasy

MxEasy makes it simple to operate the most important functions of the camera thanks to its intuitive user interface and represents a new approach to viewing and controlling MOBOTIX cameras. The clear design allows you to manage up to 16 cameras, and the application can show up to four cameras at the same time.

All settings selected in MxEasy (for example, virtual camera position, zoom, brightness, volume, microphone sensitivity, image storage, signal outputs) can be used immediately and are stored instantly in the configuration of the corresponding camera. The calendar functions integrated in the Alarm Planner provide an innovative tool for the scheduled settings of one or more cameras. This tool not only controls video and sound recording based on certain time and date information, but also allows features like video motion detection, image brightness and the microphone to be activated/deactivated based on a date and time schedule.

MxEasy – Simple Operation of the Most Important Camera Functions

- Cameras can be installed without any knowledge of networks
- Supports up to 16 MOBOTIX cameras
- Time- or event-controlled recording
- Time-controlled motion detection, image brightness and microphone
- For Microsoft Windows and Mac OS X



Suitable for up to 16 MOBOTIX cameras

Download free of charge from www.mobotix.com

No license fees
Free updates



Free download from
the **App Store**

No license fees
Free updates

1.5.4 MOBOTIX App

Premium solution: There for you whenever and wherever you need it, the MOBOTIX App serves as the perfect remote mobile station that uses intelligent detailed solutions to increase security and convenience for users on a daily basis. The controls are optimized for use with touchscreen devices and feature three main views (Live, Player, Events), self-explanatory symbols, large software buttons, multifunctional sliders developed by MOBOTIX as well as simple gestures like swipe and tap, making it easy for newcomers and older users to work with professional security equipment. In addition, using mobile devices to operate the various functions such as door opening, activating the voice mailbox, switching the door bell off at night and switching a light on/off, creates added value in the form of greater convenience and security in every day life.

MOBOTIX App – Mobile Remote Station for MOBOTIX Cameras and Door Stations

- Bandwidth-optimized remote access via WLAN (WiFi) or the Internet
- Live images and recordings in the best MOBOTIX HiRes quality
- Two-way communication, door opening and video mailbox access
- Doorbell and alarm notifications, protection of privacy
- Convenient search functions, playback of external MxPEG videos
- Grouping of cameras and filtering of events
- Free from the **App Store** for the iPad, iPad mini, iPhone and iPod touch



2 INSTALLATION

The S15 FlexMount is designed for concealed installation in ceilings, walls, behind panels or in existing or specially manufactured housings. The independent sensor models, each with a max. 3 m/9.8 ft long cable, mean the S15D can offer a number of options when selecting the installation location. The installation position of the sensor modules is crucial here. The camera module itself can then be installed in an appropriate place on the wall or ceiling (taking the maximum cable length to the sensor modules into account).

The following questions should be answered before mounting the MOBOTIX S15:

1. Where and how will the camera be mounted?
2. Where and how should the sensor modules be mounted?
3. What accessories might be needed?
4. How is the camera connected to the network and how is the power supplied?
5. How are the connections furnished from the building?
6. What cabling considerations are necessary?

The following sections in this chapter should answer all these questions. If anything is unclear or you have more questions, please contact your MOBOTIX partner or MOBOTIX Support directly. Contact information can be found at www.mobotix.com under **Support**.

2.1 Determining the Installation Position

The installation options indicated in both the following sections are examples of the most common applications for a S15 FlexMount. Many other installation ideas (for example, with customized lens units) can also be successfully implemented thanks to the robust weatherproof design (IP65) and compact shape of the sensor modules and the camera housing.

Please remember that:

1. The S15D sensor modules must always be mounted so as to avoid the constant accumulation or any collection of water or other liquid around the cable connection on the back of the housing. Otherwise this could lead to a build-up of condensation inside the sensor module and its subsequent failure.
2. Unused connectors on the housing of the S15 must always be sealed using the plugs installed as standard on delivery as well as the corresponding retainers.
3. Only original MOBOTIX cables should be used to connect the sensor modules, patch cables and USB cables in order to guarantee weather resistance according to IP65. The plugs supplied must be used if additional cables are required (MxBus, audio).
4. The lower (blue) part of the camera housing must face downwards so that any water running off the housing cannot accumulate around the connectors.

2.1.1 Positioning a Hemispheric Camera

A hemispheric camera is primarily suited to providing an excellent overview, and less suitable for more exact details. Due to its inherent physical and optical properties, the precision of the lens decreases as the distance from the lens grows. This means that the maximum usable image area greatly varies with the purpose of the camera. People, for example, may be identified very well at distances of up to 1.5 m/5 ft, and with sufficient detail up to 3 m/10 ft. Objects can be recognized even at distances of 5 m/16.4 ft and more from the camera.



Discreet ceiling installation with minimally visible technology

Ceiling-Mounted

A single S15 sensor module can monitor an entire room right into each of the four corners (360° Panorama View) thanks to its hemispheric lens. The camera should ideally be positioned on the ceiling in the center of the room. Rooms with a square floor area of up to approx. 40 m² generally allow the recognition of detail even at the borders of the full image. If you would only like to know if persons enter a room or to monitor specific objects, rooms with a floor area of well over 100 m² can also be monitored using a single sensor module.

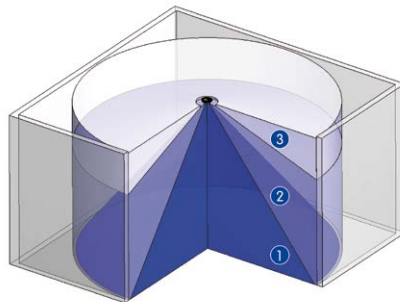

Capture of entire room

The **image quality** (precision) diminishes as the distance of an object to the camera focus point increases: 1 very good, 2 good, 3 satisfactory

Rectangular Rooms

When viewing a 360° panorama image in the browser, you will notice that the top and bottom of the image are not fully visible, i.e., some image information has been clipped. This is not the fault of the camera, but intended behavior that aims at achieving the best possible utilization of the image sensor by the camera software. Bearing this in mind, it is advisable to turn the S15 sensor module in rectangular rooms so that the area marked with two arrows or the rotary plug in a S15M (= top border or North of displayed image) is pointing towards one of the longer walls of the room.

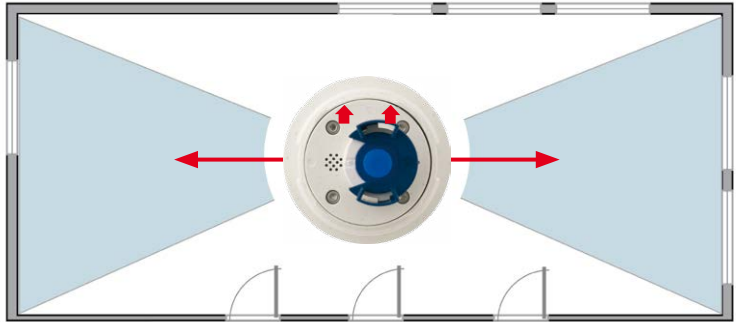

Original full image
(ceiling installation in
a rectangular room)



Wall-Mounting

To make optimal use of the high-resolution 180° panorama functionality of a hemispheric camera, the lens or sensor module must be mounted on an inside or outside wall. The entire hemisphere of the room directly in front of the camera is then effectively monitored, from the wall on the left of the camera to the wall on the right. Corresponding fine-tuning in the user interface software allows the displayed panorama image to be adjusted to different practical applications at any time..

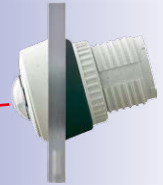

15° wedge for sensor module

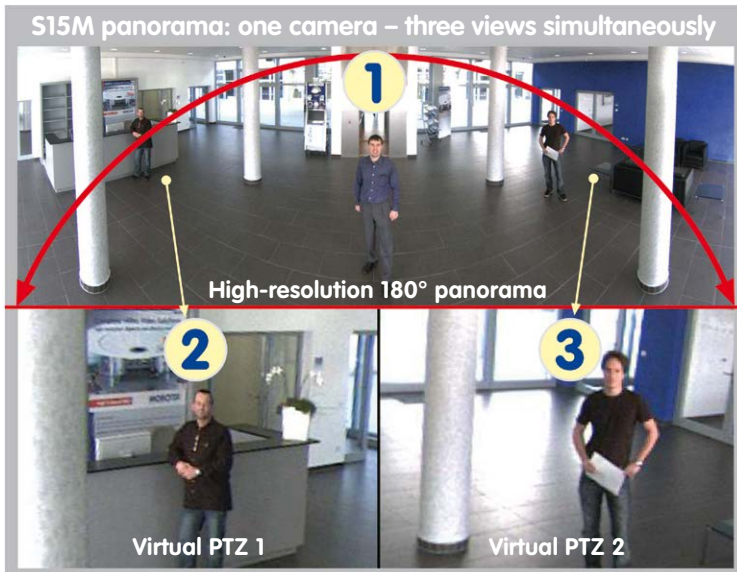

Selecting an Appropriate Camera Position

During installation, ensure that the camera is focused on the most important areas of the room as directly as possible in order to provide the desired level of detail recognition (camera focus). The S15 should be installed on a wall such that the two arrows on the back of the sensor module housing (S15D) or the rounded side of the camera housing (S15M) are pointing towards the ceiling.

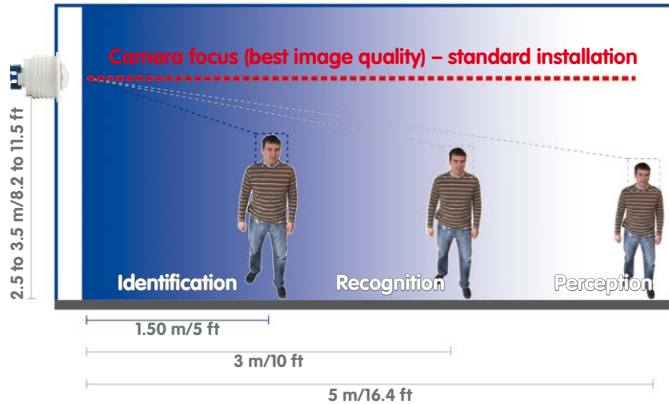

Recommendation:
Mounting the camera in
the middle of the wall

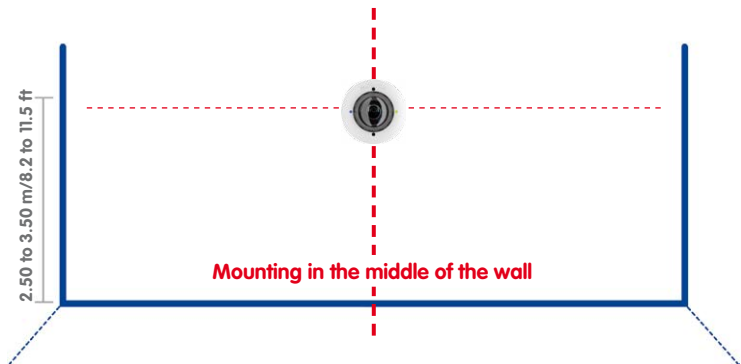

To install the sensor module on thicker walls or with the 15° wedge (see next section), the MOBOTIX offers an extension that is attached to the sensor module at the back and secured with a bayonet catch.

Determining the Installation Position

Greater wall thicknesses can also be bridged by attaching several extensions. The sensor module is secured from behind by a nut and a locknut.

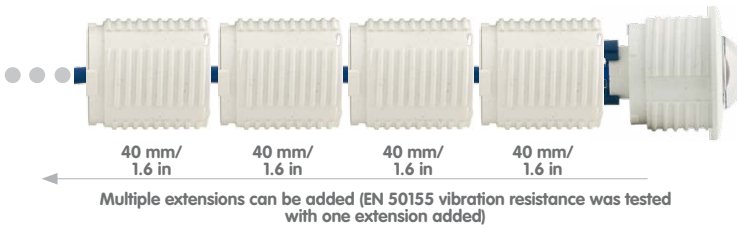

Wall Installation with 15° Wedge for Image Optimization

Wall mounting with lenses tilting downwards is recommended in many cases for optimizing image quality. In particular for wall installations that must be carried out at greater heights for technical or other reasons (over doors, windows, etc.), adding a slight tilt to the camera, and thus also the lens, will return better results, as the center of the lens is then focused more directly on the center of activity in the room (optimal utilization of lens capabilities). MOBOTIX therefore offers easy to install mounting accessories with a 15° tilt for the S15D sensor modules.

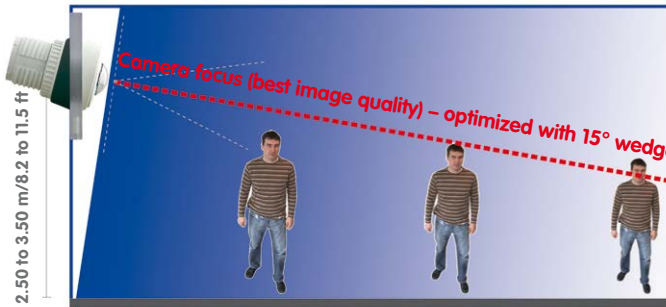

Best image quality with wall-mounting with 15° wedge

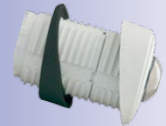

Size of the Drilling Holes with Different Material Thicknesses

Material thickness a		Diam. of drilling hole b	
mm	in	mm	in
5	0.20	47	1.85
10	0.39	48	1.89
15	0.59	50	1.97
20	0.79	51	2.01
25	0.98	52	2.05
30	1.18	53	2.09
35	1.38	55	2.17
40	1.57	57	2.24

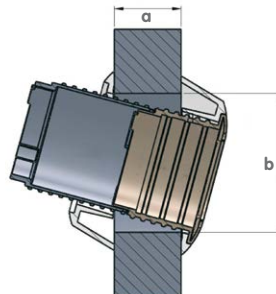

2.1.2 S15D FlexMount Installation Options

Using One or Two Sensor Modules

You can decide for yourself with the S15D whether you want to use the camera with one or two sensor modules. You can upgrade or downgrade the system at any time.

Sensor modules including status LEDs and microphone



On www.mobotix.com go to **Products > S15 FlexMount** and open the basket. It contains the **Product Configurator**. Use this to order the required parts in any of the available colors.

Produkt Preview:
Go to **Products > S15 FlexMount** to view and order accessories for the MOBOTIX S15 system.

The S15D with a single hemispheric L10-L12 sensor module therefore essentially offers the same range of functions as a standard hemispheric camera like the Q25M, but has the added advantage that it can be installed even more inconspicuously and almost completely hidden. While the sensor modules can record audio data via integrated microphones, an external speaker can be connected directly to the camera and positioned in an appropriate place. If the sensor module microphones are not used, an additional microphone can also be connected directly to the camera.

Hemispheric Day and Night Camera with Sensor Modules D10/N10 (6MP) or D12/N12 (5MP)

The S15D is the first hemispheric dual camera for use in extremely variable lighting conditions equipped with two hemispheric lenses each with a black/white and color sensor. It is important in terms of mounting, whether on a wall or ceiling, that both the camera's sensor modules are positioned directly next to each other and in parallel (arrows on sensor modules pointing in the same direction) in order to see the same image area as a color image during the day and as a black/white image at night.



Ceiling-Mounted

Indoor installation is mostly on suspended ceilings and is extremely easy. A round hole with a diameter of 45 mm/1.77 in is all that is needed, through which a S15D sensor module with connection cable and attached ferrite is pushed down through the ceiling panel, fixed from behind using a nut and then connected to the concealed base module hidden behind a ceiling panel (connector and lock).

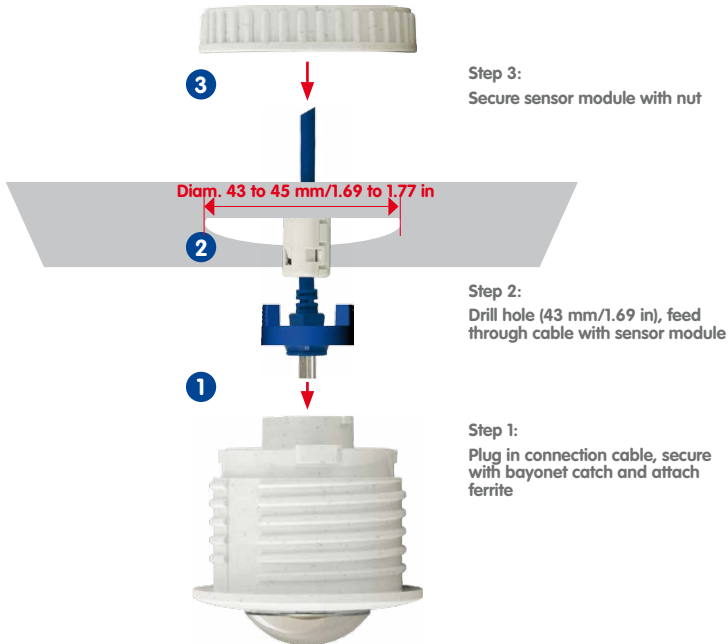

It should be ensured when selecting installation sites that each of the sensor cables do not exceed 3 m/9.8 ft (5MP – 2 m/6.6 ft). The theoretical maximum distance between the two sensor modules of a S15D where the base module is placed centrally is therefore 6 m/19.7 ft (5MP – 4 m/13.1 ft).

Caution

If there is a risk of water collecting on the back of the sensor modules (for example, in outdoor areas or in the event of extreme humidity), the modules should not be installed pointing downwards!

The S15D can, however, also be deployed at shorter distances between the two sensor modules with surprising results:

- Two adjacent areas separated by a dividing wall, shelves, floor or other form of screen can be captured without any blind spots using a S15D.

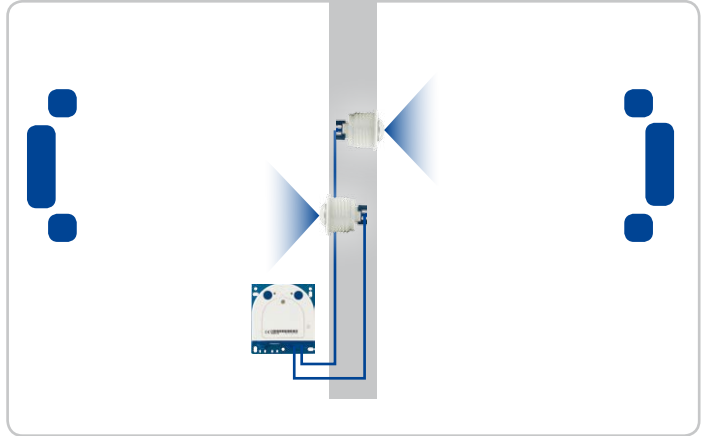

The S15D monitors two separate rooms

- In L-shaped rooms, both sensor modules are simply positioned at right angles. A S15D therefore captures the entire room without any blind spots.

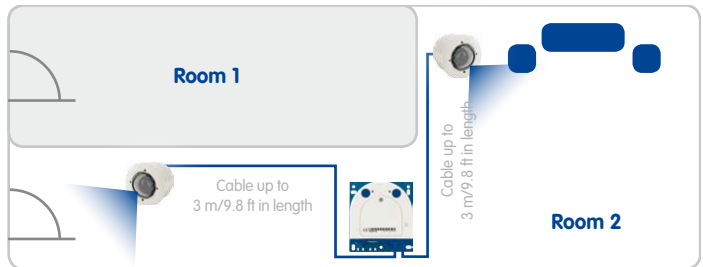

The S15D can see "around corners"

- Installing the two sensor modules next to one another, but pointing in opposite directions in particularly long, narrow rooms (for example, hotel corridors, buses, aircraft, railroad cars, etc.) delivers double hemispheric images of up to 6 megapixels that, in terms of sharpness of detail, significantly outperforms a single hemispheric camera with just one lens. For these kinds of installations, MOBOTIX will soon offer an appropriate mount in the range of accessories available for the S15 (SurroundMount). The slight downward tilt of the two sensor modules allows the area directly underneath them to be captured without any blind spots.

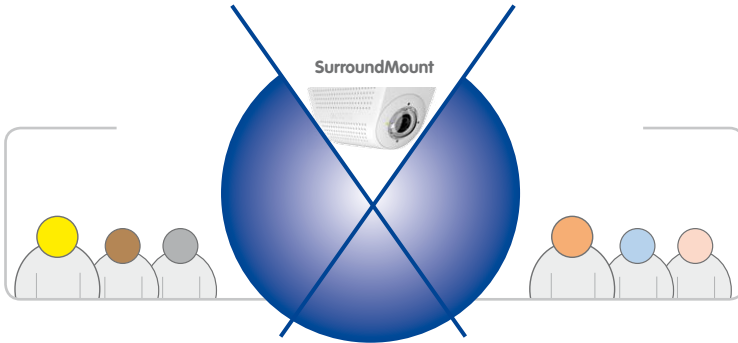

Wall-Mounting

Mounting a S15D sensor module on a wall, for example, on basic partition walls or fake walls with cavities behind the wall covering, is just as easy as mounting on a ceiling. Drill a hole 45 mm/1.77 in diameter, fit the sensor module, fix from behind with a locknut and connect to the base module. Depending on the installation height and the required camera focus, the camera can be installed with or without the wedge with 15° tilt available as an accessory.

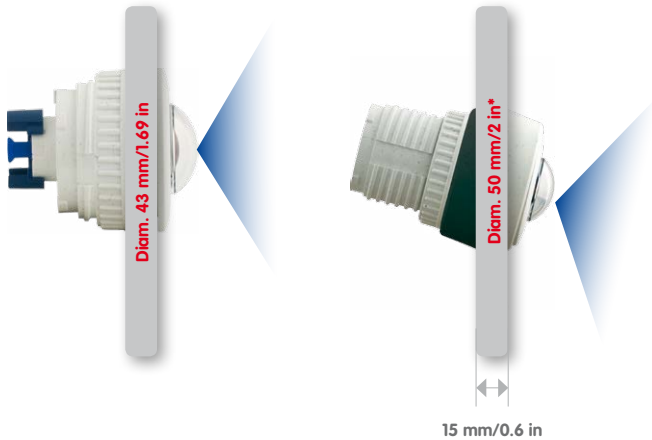

MOBOTIX also offers the appropriate installation accessories for mounting the sensor module on thicker walls. Longer "tunnel holes" through a wall can also be bridged using several extension pieces (each approx. 40 mm/1.6 in). The maximum wall thickness is therefore only limited by the length of the sensor cable depending on the installation position of the base module, which is in theory 3 m/9.8 ft.

Product preview:
SurroundMount
module with 2 x L12
sensor modules

S15D SurroundMount:
6 megapixel 360° camera

Mounting with or without
15° wedge (accessories)

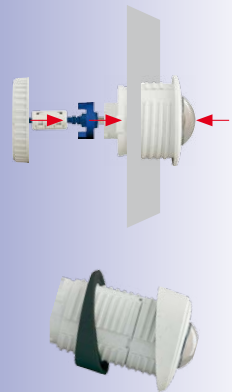

* Hole diameters vary depending on material thickness (see «Size of the Drilling Holes with Different Material Thicknesses» in Section 2.1.1, «Positioning a Hemispheric Camera»

Mixed Ceiling and Wall-Mounting

By mounting a sensor module on the ceiling of a room and at the same time attaching the second sensor module to an outside wall of this room, both the inside and the outdoor area can be captured with a single S15D at minimal installation cost.

Example: Kiosk

Simultaneous capture of the entire sales floor and the area outside the entrance with stand-up tables.

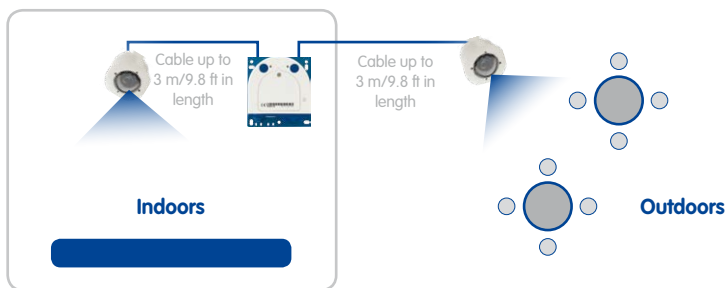

S15D simultaneously monitors indoor and outdoor areas

Floor-Mounting

Mounting sensor modules on the floor can also make sense for industrial uses or in areas where there are no people. Examples of such uses are vehicle ramps where the vehicles can also be easily captured from below.

Place sensor modules centrally between the wheels (along vehicle longitudinal axis). Sensor modules must be protected against dirt at the top by glass panels or similar!

Do not drive over or step directly on the camera or sensor modules!

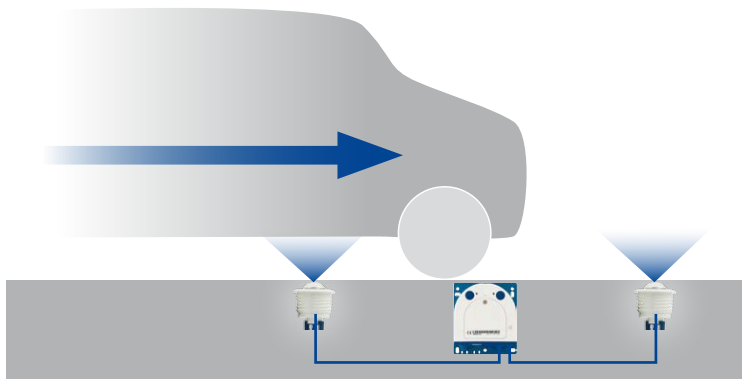

Mounting the BlockFlexMounts

BlockFlexMounts have been designed for integration into other devices. They use the same technology as the "regular" sensor modules, but in a black anodized aluminum housing. Thanks to the tap holes on each side and the holes for machine bolts, the BlockFlexMounts are easily integrated into any given structure or device.



Mounting the Sensor Modules with the PTMount

The PTMount provides for flexible, weatherproof and tamper-proof installation of MOBOTIX sensor modules. Its three axes of rotation allow installing the sensor module at any given structure and pointing it into any viewing direction.



This means that you can install the PTMount to any ceiling, wall and even upright.

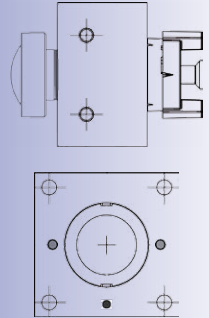

More information:
www.mobotix.com >
Products > Cameras >
S15 FlexMount

Additional Information,
Quick Installation:
www.mobotix.com >
Products > Cameras >
S15 FlexMount

Mounting the Thermal Sensor Modules

Front Plate Mounting

Tighten the cylinder head screws (red arrows) to push the pressure plate against the wall/faceplate. Hole diameter \varnothing 48 mm, possible thickness of wall/faceplate: 0 to 14 mm/0 to 0.6 in.

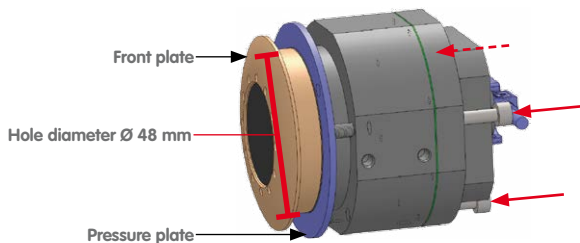

Screw Mounting

The housing can be installed by affixing suitable screws M4 (4 mm length of thread) in at least two of the six tap holes. Remove pressure plate and cylinder head screws.

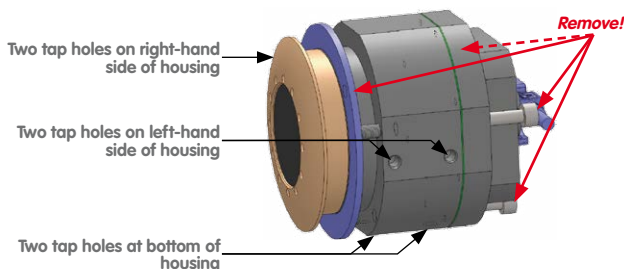

Additional Information,
Quick Installation:
www.mobotix.com >
Products > Cameras >
S15 FlexMount

For additional information on the MOBOTIX thermal sensor modules and the **Quick Installation**, see www.mobotix.com >Products > Cameras > S15 FlexMount.

2.1.3 S15M FlexMount Installation Options

Unlike the S15D, the S15M has just one lens, which does not have a flexible sensor cable, but is directly connected to the camera housing. Contrary to conventional single-lens cameras, the S15M has come up with a very neat trick:

The camera housing can be mounted concealed behind a wall up to 6.4 mm/0.25 in thick (wood paneling, stainless steel panel, etc.) with a round opening measuring 34 mm/1.34 in. The S15M can simply be fixed behind the wall and leave only the lens visible.

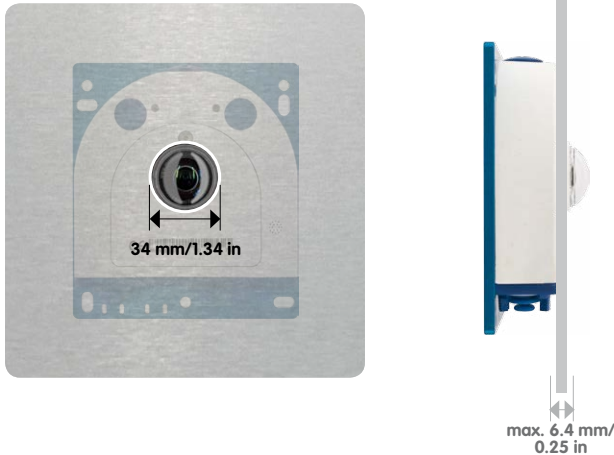

This allows the following installation options:

- Wall- and ceiling-mounting behind correspondingly thin or countersunk panels/cover plates.
- Individual mounting solutions such as installation in industrial equipment, paneling, air ducts, mail boxes, homemade mounts, etc.

Note on AudioMount

This installation frame with self-adhesive rear side allows quick mounting of the S15M behind stainless steel panels or similar materials. The mount includes pre-installed microphone and speaker.

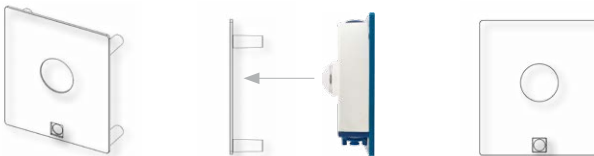

Open www.mobotix.com, go to **Products > S15 FlexMount** to view and order further accessories for the **MOBOTIX S15** system

2.2 Before Mounting

This section of the manual provides an overview of the variety of S15 connection options, the preparatory steps and the tools required for mounting.

2.2.1 Overview of Cable Connections

The following cables can be used with the S15 (see also *Section 1.4, «Available Accessories»*):

- **MOBOTIX patch cable:** This supplied MOBOTIX cable is designed for direct connection to the **MX-Patch-Box**, the **MX-NPA-Box** or a standard network port (only in indoor areas).
- **Ethernet installation cable:** As an alternative to the **MOBOTIX patch cable** (see above) an Ethernet installation cable can also be fitted directly onto the integrated LSA cutting clamp.
- **MOBOTIX USB cable with MiniUSB connector:** This MOBOTIX cable provides the required impermeability, even in adverse weather conditions, and thereby prevents corrosion of the connectors, for example, on an external USB hard drive.
- **Sensor cable for the sensor modules (S15D only):** The sensor modules are connected to the S15D via this cable. A separate cable is required for each sensor module (max. 3 m/9.8 ft).
- **Additional cable for MxBus connections, microphone and speaker:** Additional MOBOTIX modules can be connected via this multi-wire cable. The other camera opening is used for this cable or for single wires, depending on which connection is used for network cabling (patch or installation cable)

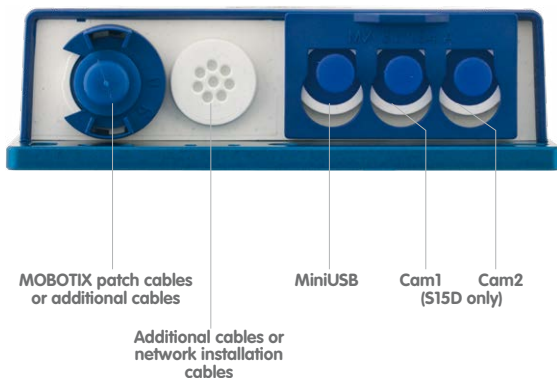

Caution

Only **MOBOTIX cables may be used for the Ethernet and USB connection** as well as **to the sensor modules (S15D)** to ensure the camera remains permanently watertight.





Unused connections must be secured using appropriate cable plugs and by closing the corresponding locks to protect the inside of the housing against water and dust.

Avoid Installing Upside-Down (Reduced Weather Protection)

If you are installing the S15 upside-down (i.e., the connectors are pointing upwards), the camera does not reach protection class IP65 any more, but only IP54. If mounted upside-down, the S15 can only be used in a dry indoor environment.

Removing MOBOTIX Cables and Plugs

The corresponding lock must first be removed or released to remove one of the cables or plugs indicated above from the S15:

Patch Cable	MiniUSB Sensor Cable
 <ol style="list-style-type: none"> 1. Turn the bayonet catch to the left. 2. Remove the bayonet catch. 3. Remove the cable/plug. 	 <ol style="list-style-type: none"> 1. Pull the triple retainer upwards (away from the base plate) until it clicks into place. 2. Remove the cable/plug.





Connectors pointing down



Connectors pointing up

Inserting and Locking MOBOTIX Cables and Plugs

The corresponding lock must be applied or closed again after inserting one of the cables or plugs indicated above into the S15:

Patch Cable	MiniUSB Sensor Cable
 <ol style="list-style-type: none">1. Insert the cable/plug.2. Attach bayonet catch.3. Turn the bayonet catch to the right.	 <ol style="list-style-type: none">1. Insert the cable/plug.2. Push the triple retainer down (towards the base plate) until it clicks into place.

2.2.2 Notes on Cable Lengths and Power Supply

- Power is supplied to the camera via the camera Ethernet connection (patch or installation cable). We recommend using a MOBOTIX PoE adapter or another similar high-quality PoE product to loop-in the power supply:
 - **One camera:** with the PoE adapter (MX-NPA-PoE or MX-NPA-Box)
 - **Multiple cameras:** with PoE products conforming to IEEE 802.3af (PoE switch)
- The **maximum length** of the network cable for power supply over an Ethernet cable is **100 m/110 yd**.
- Make sure that you only use switches or routers that support the **10/100 Mbps network interface** of the camera.
- We highly recommend using uninterruptible power supplies (UPS) to provide backup power.
- If you are using IEEE 802.3af or IEEE 802.3at (PoE+) Power-over-Ethernet network components to supply power to MOBOTIX cameras, make sure, if possible, that these components do not have a fan. Since the power consumption of MOBOTIX cameras is very low compared to other products, the reliability of the entire system is increased, thus extending the life of these components.

Caution

If the camera's power supply has been set to PoE Class 3, you can attach modules to the MxBus **and** USB connectors that do not exceed a total power consumption of 4 W. If the camera is using **PoE Class 2**, **the total power consumption of all attached modules must not exceed 1 W!**

For more information on changing the PoE class, please see *Section 2.5.7, «Variable PoE»*.

When attaching modules with a total power consumption of more than 1 W (via MxBus/USB):
Max. ambient temperature +50°C/122°F

2.2.3 Network Connection with MOBOTIX Patch Cable

The supplied **MOBOTIX patch cable** can be used to connect the camera to an **MX-Patch-Box**, an **MX-NPA-Box** or to a standard network port.

Connecting the Patch Cable to the Camera

First remove the blue bayonet catch and the blue sealing plug in the left-hand connector on the S15. Then insert the MOBOTIX patch cable into the camera and secure the cable using the bayonet catch.

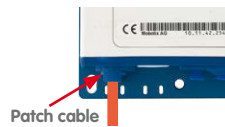

Connecting the Patch Cable to an MX-Patch-Box, MX-NPA-Box or Standard Network Port

First remove the blue bayonet catch and the blue sealing plug in the right-hand connector on the box to establish the network connection to an MX-Patch-Box or MX-NPA-Box. Then insert the MOBOTIX patch cable into the box and secure the cable using the bayonet catch.

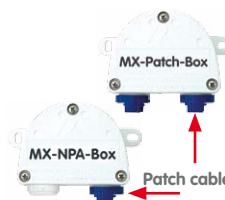

More information on installing an **MX-Patch-Box** or **MX-NPA-Box** is available at www.mobotix.com under **Products > Accessories > Functional Boxes**.

Insert the MOBOTIX patch cable of the S15 into the network port for standard connections (only permitted in indoor areas).

Connecting Peripheral Devices (MxBus, Microphone, Speaker)

The opening provided for the installation cable must be used for all other cables that are connected to the camera when using the MOBOTIX patch cable. Depending on the cable used, the single wire plug installed must be replaced with one of the other cable plugs (M.4/5).

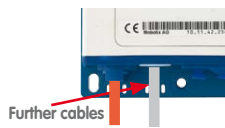

The cable used must be fixed to the circuit board using one of the cable ties supplied (M.9) to ensure that less strain is placed on the cable. The individual cable wires must be fixed on the screw clamps using the the screwdriver supplied (M.9).

2.2.4 Network Connection with Installation Cable

As an alternative to connection to an MX-Patch-Box, MX-NPA-Box or standard network port, you can also connect the S15 directly to an **installation cable**. Since the housing cover of the camera must be opened for this purpose, this working step **in a S15M must be carried out before** mounting the camera as the housing cover is no longer accessible once it has been mounted.

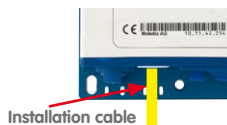

The installation cable is fixed onto the circuit board before fitting the wires onto the LSA cutting clamps using one of the cable ties supplied (M.9) to ensure less strain is placed on the cable and that the camera is earthed correctly.

Connecting Peripheral Devices (MxBus, Microphone, Speaker)

The opening provided for the MOBOTIX patch cable must be used for all other cables that are connected to the camera when using an installation cable. The blue bayonet catch and the blue sealing plug in the left-hand connector must be removed for this purpose. The single wire plug or one of the other cable plugs (M.4/5) is then pushed into the opening, depending on the cable used. The bayonet catch will no longer be used.

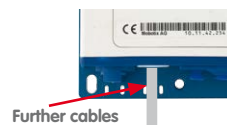

The cable used must be fixed to the **base plate** using one of the cable ties supplied (M.9) to ensure that less strain is placed on the cable. The individual cable wires must be fixed on the screw clamps using the the screwdriver supplied (M.9).

2.2.5 Using Sensor Modules (S15D Only)

One or two sensor modules can be connected via both right-hand connectors in the S15D. For this purpose, the lock is pulled forward, the central and right-hand (or only the central plug if only one sensor module is used) is removed and the corresponding sensor cable is inserted. The connectors are waterproof again once the lock is pressed down.

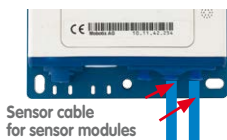

2.2.6 Using the MiniUSB Cable

Existing add-on modules such as the MOBOTIX ExtIO (USB) or external USB hard drives can be connected via the MiniUSB connector. For this purpose, the lock is pulled forward, the left-hand plug is removed and the MiniUSB cable is inserted. The connectors are waterproof again once the lock is pressed down.

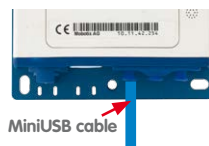

2.2.7 Using MxBus Modules

The MxBus camera connector is located under the housing cover (clamps 5 and 6 of the screw clamps) and allows the operation of additional modules for expanding functionality (e.g. connection of an MX-GPS-Box for determining time and position). MxBus was optimized specifically for the use of existing two-wire cables.

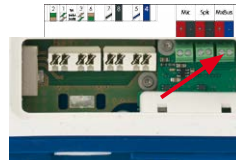

The terminal connector has two connectors to connect an MxBus module (other MxBus modules can then be connected from there). The length of the entire MxBus cable may not exceed 50 m/55 yd.

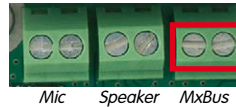

Note

The MxBus wires that are to be stripped at the end should always be fed into the camera through appropriate plugs before mounting. If the single wire plug is used, one wire must be pushed through a hole in the plug.



Do not mix up the polarity of the cables during installation. Select a consistent cable color for +/- in the entire MxBus system (for example, red = +, blue = -)

After an MxBus module has been connected, the MxBus itself must be started in the camera's web-based user interface (if this has not been done yet) as well as the actual module (**Admin Menu > Manage Hardware Expansions or MxBus Modules**).

2.2.8 External Audio Support (Microphone/Speaker)

The camera connector for an external microphone and an external speaker is located under the housing cover (clamps 1 and 2 of the screw clamps for microphone, clamps 3 and 4 for speaker).

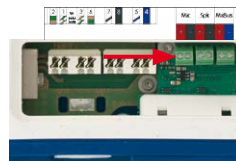

An external microphone (red box) and an external speaker (red box) with the following technical data can be connected on the terminal connector:

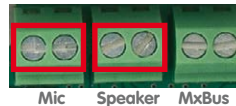

- **Microphone:** $V_s = 2.0 \text{ V}$, $R_L = 2.2 \text{ k}\Omega$, sensitivity $-35 \pm 4 \text{ dB}$, for example, Panasonic Microphone Capsule WM61
- **Speaker:** Max. power output 400 mW at 8 Ohms impedance, for example, Visaton Speaker K36WP or K50WP

Replace the MicroSD card only if the camera is disconnected from the power supply!

Push the MicroSD card in once (Push), then pull out using tweezers



2.2.9 Replacing the MicroSD Card

If the pre-installed MicroSD card needs to be replaced (for example, with a 64 GB MicroSD card), it is best to do so **before** the camera is installed. **MicroSD cards should only be replaced when the camera is disconnected from the power supply.**

1. **Remove rotary plug:** Loosen the rotary plug at the top of the housing, for example, using a suitable coin and remove the plug.



2. **Remove the MicroSD card:** Carefully push the MicroSD card into the holder using a pair of tweezers until you hear a **click**. The card is now sticking out slightly and can be removed using the tweezers.



3. **Insert the MicroSD card:** Push the MicroSD card as shown (electrical contacts pointing towards the front) into the card slot using a pair of tweezers. Make sure that you hear a **click** when the card is inserted. The card is now locked and can be used. **If you are using a new MicroSD card, it needs to be formatted first** (see Section 3.5.2, «Formatting the MicroSD Card»).



4. **Attach the rotary plug:** Insert the rotary plug as shown and screw it tight using a coin (approximately two turns, the plug slot is pointing forwards).



2.2.10 Tools Required for Installation

Please make sure that all the camera components are included in the original packaging (see Section 1.3.1, «S15D Core (Base Module)», Section 1.3.2, «Sensor Modules L10-L12*» and Section 1.3.8, «S15M»).

Additional Tools/Materials Required

- **Any additional materials required for attaching the camera to a ceiling/wall (four wood screws including screw anchors and washers) are included in the original packaging.**
- **Screwdriver with PZ 2 driver bit**
- Potentially a **power drill and 6-mm drill bit** for screw anchor holes for attaching the base plate
- **Drilling template** for base plate and, where appropriate, sensor module (at the end of this manual)

- **Scissors** to cut out the template.
- **Pencil** to mark the drill holes
- Optionally **LSA+ tool** for fitting an installation cable onto the LSA terminals of the camera
- **Hole saw** or **Forstner drill** with 44 to 45 mm/1.77 in diameter for the S15D sensor modules or with 35 mm/1.38 in diameter for the S15M lens
- **Soft cotton cloth** to clean the front of the lens after installation

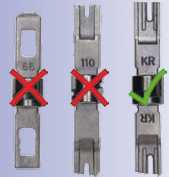

Only use the LSA/
Krone blade and set
to LOW impact!

2.2.11 Preparatory Steps

Make sure of the following before starting to install the camera:

- **Connection with MOBOTIX patch cable:** The network connector has been guided either with an MX-Patch-Box, an MX-NPA-Box or a standard network port (only permitted in indoor areas) into the vicinity of the mounting position of the camera.
- **Connection with installation cable:** If a network installation cable is used instead, it may not conduct any voltage and may not be connected to the network.
- **Even surface:** Make sure before attaching the camera that the surface is even so that the base plate of the camera does not move.
- **Pressure equalization element:** This element on the housing of the S15 and the sensor modules must be kept free to enable pressure equalization element of the camera housing.



S15D/S15M
FlexMount (front)



Sensor module (rear)

Do not cover pressure
equalization elements

LED defaults:

- 1 Power (on), Error (flashes)
- 2 Recording (flashes)

2.3 Installing the S15D FlexMount

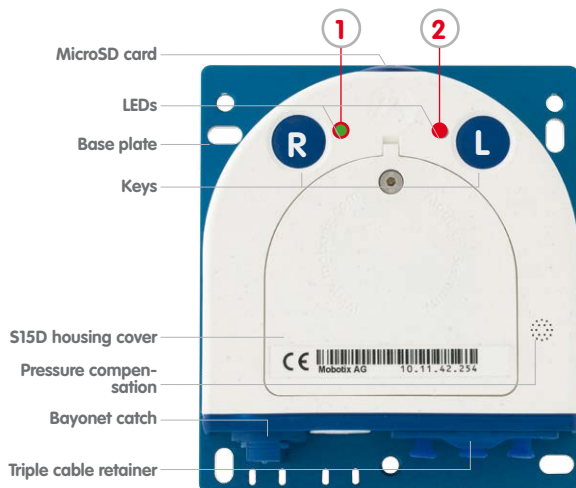

The drilling templates can be found at the end of the manual

Always print or copy drilling templates in their original size



Use the **drilling templates supplied** (at the end of the manual) to mark the position for drilling the dowel holes for the camera and the sensor modules. Make sure that it is not scaled down when printing or copying the drilling template.

Caution

Make sure the camera is mounted on an **even surface**. If this is not the case, there is a risk that the housing plate will move and the housing will begin to leak.

The **torque** for the **housing cover screws** is **0.4 Nm**.

Only exchange sensor modules when powered off: Make sure that the camera's power supply has been disconnected before attempting to exchange any sensor modules.

2.3.1 Attaching the S15D Base Module

Depending on the system, the base module of a S15D can be installed quickly:

1. If necessary, mark the drill holes at the intended mounting position, drill the holes for the base plate and hammer in the **6 mm dowels** supplied.



- If this has not been done already, insert the cable tie needed to ensure that less strain is placed on the connection cable into the slot provided below in the base plate without closing it.
- Screw on the S15D base module using the **4x40 mm screws** included (or other suitable screws) and **washers (with a diam. of 4.3 mm)**.

2.3.2 Attaching and Connecting the S15D Sensor Modules

Before installing the sensor modules, make sure that the sensor cables will reach the intended mounting position without placing a strain on the cables. Further information on the individual camera connectors can be found in *Section 2.2.1, «Overview of Cable Connections»*.

- Drill the hole for the sensor module at the intended mounting position (arrow on the back of the sensor module pointing "Up").
- Connect the sensor cable to the sensor module (turn the blue bayonet catch to the left and lift off, remove the plug, insert the sensor cable, replace the bayonet catch and turn to the right). Make sure that the sensor cables are not sharply bent anywhere!
- Attach one ferrite at each end of the sensor cable (max. distance to the plug 10 cm/4 in, as shown in the figure).



- If extensions are required (at least one in sensor module L12 and 15° wedge), they should now be pushed over the sensor cable and joined to the sensor module or extensions that have already been mounted using the bayonet catch (see *Section 2.3.3, «Plugging in and Removing Extensions»*).

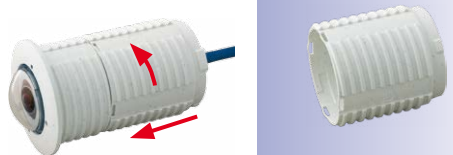

Only **MOBOTIX cables** should be used to connect the sensor modules (see *Section 1.4.3, «Connection Cable for Sensor Module»*)

The sensor module connection cables must never be bent sharply!



Make sure **MOBOTIX** lettering is pointing upwards!

If you install a S15D with automatic day/night switching, make sure to connect the D11 (day) sensor module on the **Cam1** and the N11 (night) sensor module on **Cam2**



- If a 15° wedge is used, the visible wedge and the wedge sealing must now be pushed onto the cable, the sensor module and any extensions already mounted (the thicker side of the wedge is at the top). Make sure that the **MOBOTIX** lettering at the front of the sensor module is pointing upwards!

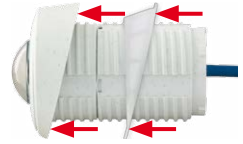

- Now insert the cable and then push the whole sensor module (including wedge, wedge sealing and extension, if installed) through the hole.

- If a 15° wedge has been fitted, the second wedge sealing and the second wedge must now be pushed over the sensor cable, any installed extensions and the sensor module (the thicker side of the wedge is at the bottom) may need to be shifted to ensure that the nut is properly positioned on the back.

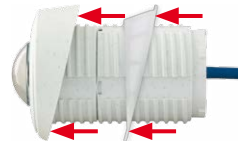

- Feed the sensor cable through the nut and secure the sensor module and mounted extensions using that nut. If you need to seal off the sensor module against the wall, you should apply silicone sealant before tightening the nut.

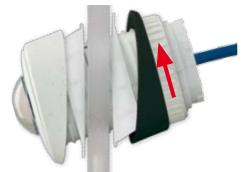

- Attach the sensor cable of the first sensor module to the **Cam1** connector and the sensor cable of the second sensor module to the **Cam2** connector of the S15D (pull the blue triple cable retainer up, remove the plug, insert the sensor cable and push the cable retainer down again).



2.3.3 Plugging in and Removing Extensions

The extensions are fixed onto the sensor modules (or other extensions) with the help of a bayonet catch.

Attaching Extensions

- Turn the sensor module so that the larger lobe (red arrow on the illustration) is at the front. The other three lobes are smaller and do not protrude (blue arrows).

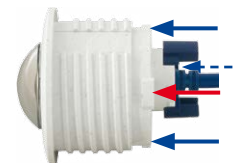

- Turn the extension so that the larger lobe on the extension is slightly offset from the lobe on the sensor module (see blue box in the illustration on the right). Push the extension with the notches onto the sensor module.

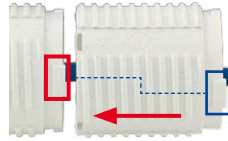

- Turn the extension in a clockwise direction until it clicks into place (viewed from the right). The extension will lock automatically and will not turn, even if the nuts are loosened.

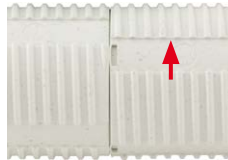

Note

Make sure that the extensions are always connected as described in Step 2. Attaching the extensions incorrectly will damage the bayonet catch and may result in the nuts not being properly attached.

Removing Extensions

Proceed as follows to loosen and undo an extension lock:

- Push the extension towards the sensor module to unlock it.
- Turn the extension in an anti-clockwise direction (viewed from the back) to open the bayonet catch.

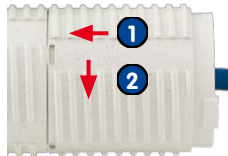

- Remove the extension.

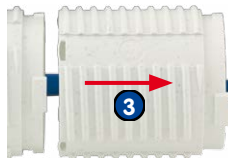

2.3.4 Connecting Network Cables and Additional S15D Cables

Once you have mounted the S15D and the sensor modules you can connect the network cables of the camera, a MiniUSB cable, if required, and additional cables (MxBus, microphone, speaker) as described in *Section 2.5, «Network and Power Connection, Additional Cables»*

LED defaults:

- 1 Power (on), Error (flashes)
- 2 Recording (flashes)

2.4 Installing the S15M FlexMount

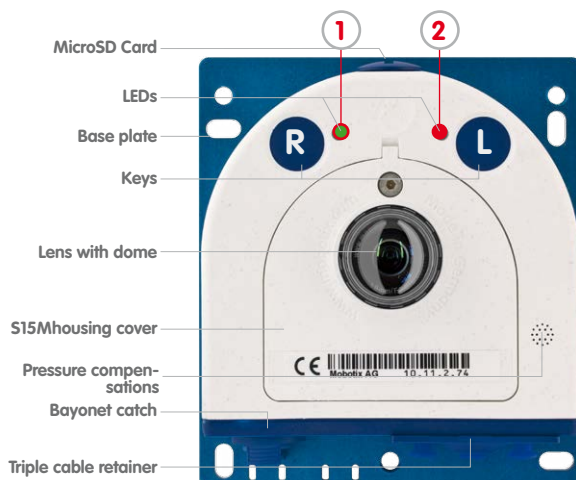

2.4.1 Connecting Network Cables and Additional S15M Cables

As the S15M is mounted in the intended position with the front panel behind, the housing cover cannot be removed after mounting. All the cables to be connected there (Ethernet installation cable, MxBus, microphone, speaker) are then no longer accessible and the connector for the network patch cable can only be accessed with difficulty. The triple lock for connecting the MiniUSB cable can no longer be opened either. This is why you should connect the camera network cables, a MiniUSB cable, if required, and additional cables (MxBus, microphone, speaker) **before mounting the camera** as described in *Section 2.5, «Network and Power Connection, Additional Cables»*.

2.4.2 Attaching the S15M Camera Housing

Use the **drilling template supplied** (at the end of this manual) to mark the position of the drilling holes for the camera. Make sure that it is not scaled down when printing or copying the drilling template.

The drilling templates can be found at the end of the manual

Always print or copy drilling templates in their original size

Caution

Make sure the camera is mounted on an **even surface**. If this is not the case, there is a risk that the housing plate will move and the housing will begin to leak.

The **torque** for the **housing cover screws** is **0.4 Nm**.

Attachment to a Rear Wall

If the S15M is attached with the base plate on a rear wall (and then, for example, to a separate stainless steel cover), the camera can be mounted in just a few steps:

1. If necessary, mark the drill holes at the intended mounting position, drill the holes for the base plate and hammer in the **6 mm dowels** supplied.
2. If this has not been done already, insert the cable tie needed to ensure that less strain is placed on the connection cable into the slot provided below in the base plate without closing it.
3. Screw on the S15M with the **4x40 mm screws** included (or other suitable screws) and **washers (with a diam. of 4.3 mm)**.
4. Mark the hole for the camera lens in the cover using the drilling template for the S15M and drill a hole there with a 35 mm/1.38 in diameter.
5. Place the cover over the camera and the cables.



Attachment Behind Screens, Walls or Ceiling Elements

This type of mounting can be completed using various attachment elements.

- Bonded nuts with stud bolts, nuts and washers as shown in the illustration.
- Thicker materials (greater than 6.4 mm/0.25 in) need to be machined accordingly in order to accommodate the camera housing. They can then be attached using anchor nuts or screw sockets as well as stud bolts, nuts and washers or similar.

Make sure that there is enough space behind the mounting surface for the camera and that the pressure equalization of the camera is also free after mounting.

1. Mark the hole for the camera lens in the cover using the drilling template for the S15M and drill a hole there with a 35 mm/1.38 in diameter.
2. Mark the places on the mounting surface where the nuts are to be placed with the help of the drilling template.
3. Tighten the stud bolts, nuts and washers.
4. Place the camera from behind onto the prepared attachment elements and screw the camera on tightly (secure nuts with a screw locking device to prevent them from becoming loose).



MOBOTIX offers a mounting kit (accessories) for this type of attachment

2.5 Network and Power Connection, Additional Cables

2.5.1 Network Cabling for S15 with Patch Cables

Using a patch cable and an MX-Patch-Box or MX-NPA-Box offers the following advantages:

- Quick installation/deinstallation
- No shortening of the cable in the event of multiple installation/removal
- Connection that is dust-proof/resistant against water jets in accordance with IP65

Connecting the Patch Cable to the Camera

First remove the blue bayonet catch and the blue sealing plug in the left-hand connector on the S15. Then insert the MOBOTIX patch cable into the camera and secure the cable using the bayonet catch.

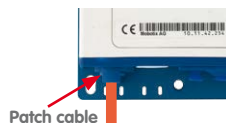

Connecting the Patch Cable to an MX-Patch-Box, MX-NPA-Box or Standard Network Port

First remove the blue bayonet catch and the blue sealing plug in the right-hand connector on the box to establish the network connection to an MX-Patch-Box or MX-NPA-Box. Then insert the MOBOTIX patch cable into the box and secure the cable using the bayonet catch.

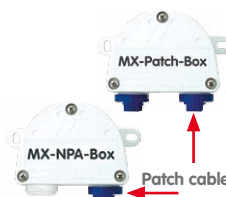

More information on installing an **MX-Patch-Box** or **MX-NPA-Box** is available at www.mobotix.com under **Products > Accessories > Functional Boxes**.

Insert the MOBOTIX patch cable of the S15 into the network port for standard connections (only permitted in indoor areas).

If additional cables are required inside the housing (MxBus, microphone, speaker), they must be connected as described in *Section 2.5.3, «Connecting Additional Cables»*.

2.5.2 Network Cabling for S15 with Installation Cables

1. **Remove housing cover and cable plugs:** Loosen the Allen screw on the housing cover of the S15 and remove it. Push the cable plug in the camera out of the housing from the inside to the outside (red arrow).



2. **Attach the cable ties:** Feed one of the cable ties supplied through both slots in the circuit board underneath the LSA cutting clamp.

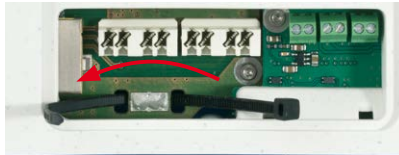

3. **Prepare the installation cable:** Cut the installation cable to length, feed through the white single wire plug (5-7 mm/0.2 to 0.28 in), remove 35 mm/1.38 in of insulation and separate into individual twisted wire pairs including 15 mm/0.6 in sheathing. Wind the shield mesh around the sheath to a width of 10 mm/0.4 in so that it can be fixed on the contact surface later using the cable tie.

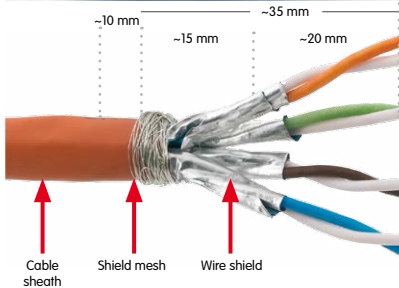

4. **Secure the cable:** Push the plug out and insert the installation cable with single wire plug (5-7 mm/0.2 to 0.28 in) into the opening intended for the installation cable. The rubber sleeve must sit tightly on the installation cable to prevent the penetration of moisture. Tighten the cable tie around the shield mesh to ensure less tension.

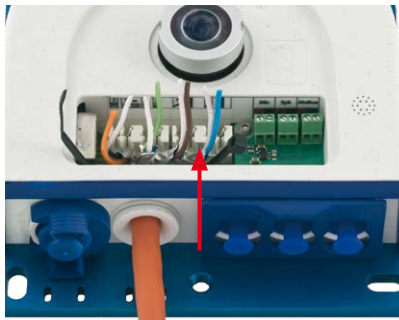

5. **Connecting the cable wires:** The individual wires of the installation cable can be connected to the LSA cutting clamp using an appropriate tool and in accordance with the EIA/TIA-568A or B standard used (see printed color coding above the clamp; see red arrow in the illustration below).

Ensure that the installation cable is fed right into the housing when the camera is in the right position so that the cable plug provides optimal sealing for the housing

Caution

Make sure that **all cable end offcuts are removed from inside the camera**. If not, this could lead to **short circuits!**

Hint: Hold the cable ends firm before cutting them with the LSA+ tool.

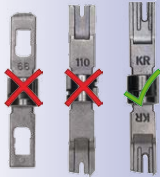

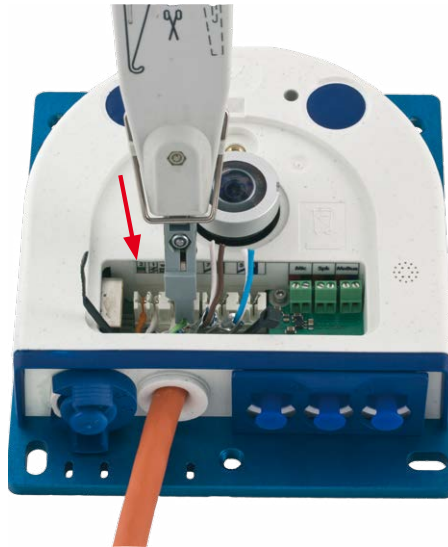

Only use the LSA/
Krone blade and set
to LOW impact!



If additional cables are required inside the housing (MxBus, microphone, speaker), they must be connected as described in *Section 2.5.3, «Connecting Additional Cables»*.

2.5.3 Connecting Additional Cables

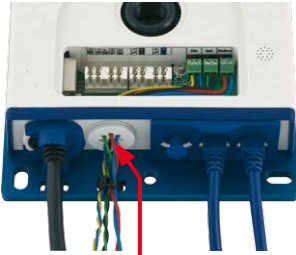
Additional cables can be fed through the free opening in the housing, depending on the Ethernet connector used (patch cable or installation cable). If an installation cable is used, additional cables should be installed after the installation cable has been fitted.

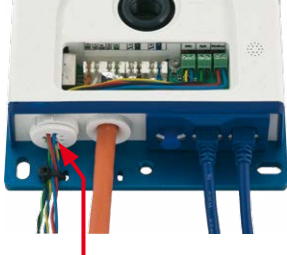
Ethernet via Patch Cable	Ethernet via Installation Cable
 <p data-bbox="135 651 370 687">Additional cables (MxBus, microphone, speaker)</p> <ol data-bbox="105 730 454 807" style="list-style-type: none"> 1. Replace any single wire plugs with appropriate cable plugs (M.4/5) for additional cables. 	 <p data-bbox="501 651 736 687">Additional cables (MxBus, microphone, speaker)</p> <ol data-bbox="474 730 824 863" style="list-style-type: none"> 1. Remove the bayonet catch and the patch cable and push the single wire plug or appropriate cable plug (M.4/5) in so that the edges protrude inside. The bayonet catch will no longer be used.

2. Push the single wire plug with the individual wires through or push the cable with sheathing through the cable plug.
3. Connect the wires to the corresponding screw terminals with the help of the screwdriver supplied.
4. Fix single wires or cables to the base plate using one of the cable ties supplied.
5. Connect wires to the corresponding devices (MxBus module, microphone, speaker).



The IP addresses in the diagram are shown only as an example

For the S15 you should use the blue MX-NPA-PoE-Set or the MX-NPA-Box - previous MOBOTIX network power accessories, such as the NPA-Set, Power-Box and Power-Rack (MX-NPA-Set, MX-NPR-4 and MX-NPRB/20) are not suitable for use with the S15



2.5.4 Power Supply Using a Switch

1. Connect the factory pre-installed cable of the camera to the **Camera** connector of the PoE adapter.
2. Connect the **LAN/Power** connector of the PoE adapter to the Ethernet connector of the switch/router or the Ethernet port.
3. Plug the RJ45 connector of the power supply unit into the **PC/Power** connector of the PoE adapter.

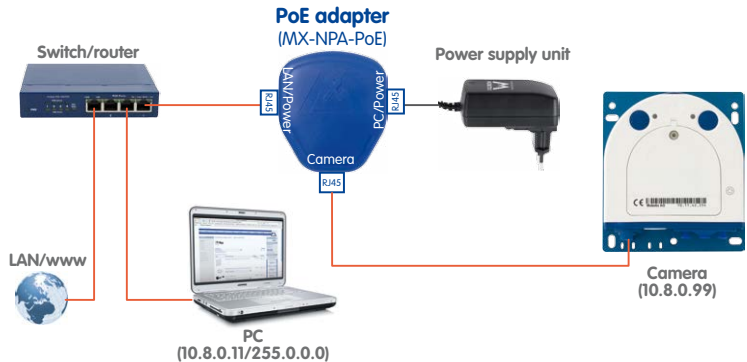

2.5.5 Power Supply When Connected Directly to a Computer

1. Connect the factory pre-installed cable of the camera to the **Camera** connector of the PoE adapter.
2. Connect the **PC/Power** connector of the PoE adapter to the Ethernet port of the computer.
3. Plug the RJ45 connector of the power supply unit into the **LAN/Power** connector of the PoE adapter.

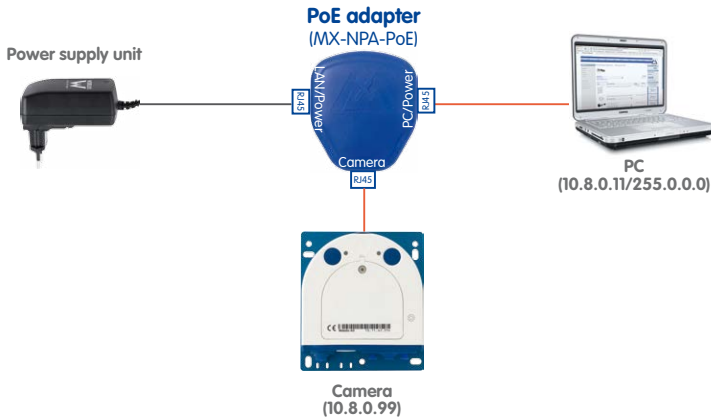

The IP addresses in the diagram are shown only as an example

The PoE adapter replaces the crossover cable when directly connecting to a computer

For the S15 you should use the blue MX-NPA-PoE-Set or the MX-NPA-Box - previous MOBOTIX network power accessories, such as the NPA-Set, Power-Box and Power-Rack (MX-NPA-Set, MX-NPR-4 and MX-NPR8/20) are not suitable for use with the S15



2.5.6 Power Supply with Power-Over-Ethernet Products

Connect the factory pre-installed cable of the camera to the Ethernet connector of the PoE switch/router. The switch/router must support the PoE standards IEEE 802.3af or IEEE 802.3at.

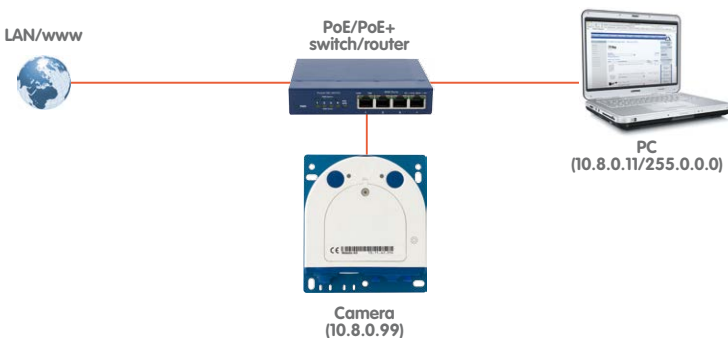

The IP addresses in the diagram are shown only as an example

2.5.7 Variable PoE

The power consumption of the camera depends on the functions in use as well as any peripheral devices connected (see table). PoE classes 1, 2 or 3 may be selected in the browser-based user interface in order to optimally adjust the camera to your system design (PoE switch in use, emergency power concept, etc.).

PoE Power Level Classes (IEEE 802.3af standard)		
Class	Max. power consumption	Camera operating mode and peripheral devices
2	3.84 W–6.49 W	Normal mode; max. 1 W for MxBus peripheral devices
3	6.49 W–12.95 W	FullPower mode; max. 2.5 W for MxBus peripheral devices (for example, MX-GPS-Box and MX-232-IO-Box to MxBus), max. 4 W for peripheral devices to MxBus and USB interface

Caution

If the total power consumption of the camera and peripheral devices exceeds the power provided by the PoE switch for the specified class, the switch can disconnect the camera from the power supply. ***In this case, the camera will only be accessible again once the peripheral devices have been disconnected from the camera and the camera has been restarted.***

When using thermal sensor modules on an S15D, **which had been set to PoE Class 2 before, you need to set the camera to use PoE Class 3 before connecting the sensor modules!**

Variable PoE:
Multiple cameras
can be operated
simultaneously from
the same switch

The default setting is usually fine, and nothing needs to be changed. However, the PoE power class must be changed in the browser if a higher or a lower power class is required for your application:

1. Select **Admin Menu > Network Setup > Ethernet Interface**.
2. Click on **Change** under **Power Supply**.
3. Follow the instructions in the **Power over Ethernet (PoE)** dialog, which will guide you through the PoE configuration steps.
4. Next, restart the camera: Disconnect the camera from the power supply. Then reconnect it, for example, by disconnecting and then reconnecting the Ethernet cable at the PoE switch.

The screenshot shows the MOBOTIX web interface for configuring the Ethernet interface. The 'Power over Ethernet (Class 2)' option is highlighted with a red circle. The interface includes sections for 'Allgemeine Konfiguration', 'Stromversorgung', 'Zweite IP-Adresse', 'Power Wizard', and 'Stromversorgung'.

2.5.8 Camera Startup Sequence

As soon as the power supply has been established, LEDs 1 and 2 will show the progress of the startup sequence.



LED defaults:

- 1 Power (on), Error (flashes)
- 2 Recording (flashes)

- **Booting:** Immediately after connecting the power supply, the red LED lights up, blinks for two seconds, then stays on permanently red. A camera self-test is carried out at this point, and the entire system is started. In case of an error, the camera will start using the backup operating system.
- **Waiting for key pressed:** Both LEDs light up for four seconds. If you press the **R** or **L** key of the camera during this time, the camera will execute the corresponding function (see Section 3.2.5, «Starting the Camera with the Factory IP Address» and Section 3.2.6, «Starting the Camera with an Automatic IP Address (DHCP)»).
- **Ready:** Once the camera software has been started, the green LED is on permanently and the red LED blinks. The camera can now be accessed via the network (browser, MxControlCenter, MxEasy, MOBOTIX App, etc.).



Note

During the startup sequence of the camera, the LEDs will always light up, even if they have been deactivated in **Admin Menu > LED Setup**.

MxEasy and the MxControlCenter control room software are available for free download from www.mobotix.com

Camera software in the browser

3 OPERATING THE CAMERA

3.1 Manual and Automatic Operation

MOBOTIX cameras do not require any extra software. Thus, you can set up and operate the MOBOTIX camera using a JavaScript-enabled browser on all common operating systems (such as Windows, Linux, Apple, etc.). As an alternative, you can also use the MOBOTIX applications MxControlCenter and MxEasy. Follow these steps to set up the camera:

1. **Connect the camera to the network.** Power is supplied directly via the Ethernet cable (see Section 2.5, «Network and Power Connection, Additional Cables»).
2. **Set up the camera's network parameters:**
 - **Manually using a web browser** (see Section 3.2.1)
 - **Automatically using MxControlCenter/MxEasy** (see Section 3.2.3 and Section 3.2.4) or **via DHCP** (see Section 3.2.6)
3. **Configure the camera** using the web-based user interface, MxControlCenter or MxEasy.

Every MOBOTIX camera comes preconfigured with a static IP address in the 10.x.x range (for example, 10.8.0.99). However, local computer networks usually have IP addresses in the 172 or 192 ranges. MOBOTIX cameras must therefore also be given an IP address in this address range to ensure that they can be accessed via the network. You can **set up the network parameters of a MOBOTIX camera** using one of the following methods: **Manually**, using **MxCC** and **MxEasy** or by **DHCP**.



3.1.1 Manually Using a Computer in the 10.x.x.x IP Address Range

You can set up the camera's network parameters using a browser and the embedded camera software. To do so, connect the camera to a computer or network that is using a 10.x.x.x IP address range (see Section 3.2.1, «Manually Setting Up the Network Parameters in a Browser»). Afterwards, you can enter the camera's default IP address in the browser's address bar on your computer (see Section 3.2.2, «First Images and the Most Important Settings in the Browser»). Next, click on the **Admin Menu** button to

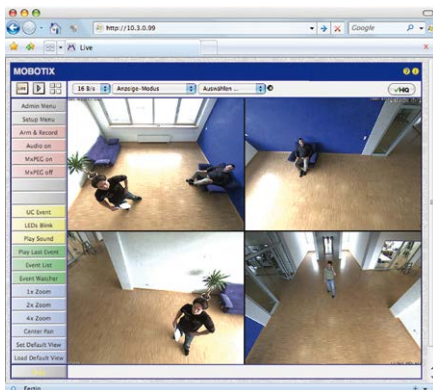

open the camera's Quick Installation in the browser's user interface. This is where you can configure the desired network parameters of the camera. Once you have completed the Quick Installation, you can connect the camera with its new network parameters to the desired network.

Benefits

- The camera does not need to be physically accessible, that is, it can remain mounted to a pole, for example.
- No additional software is required.
- The network parameters can be set flexibly through manual entry.

Disadvantages

- The computer or the network needs to operate in the 10.x.x.x IP address range or need to be able to access such a network.
- The setup does not work automatically.
- You need to know the relevant network parameters.

3.1.2 Automatically Using MxControlCenter or MxEasy

You can set up the camera's network parameters using the free video management software MxControlCenter or MxEasy (see *Section 3.2.3* and *Section 3.2.4*). You can also use one of these applications to automatically configure the network parameters of a MOBOTIX camera that is not operating in the same IP address range as the computer.

MxControlCenter control room software (free download from www.mobotix.com)



MxEasy (free download from www.mobotix.com)

Benefits

- You can connect the camera directly to the target network.
- The camera does not need to be physically accessible, that is, it can remain mounted to a pole, for example.
- The camera can be configured to automatically receive an IP address (optional).
- The network parameters can be manually set (optional).
- You do not need to access the camera software.

Requirement

- Either MxControlCenter or MxEasy must be installed on the computer.

3.1.3 Automatically Using DHCP

The camera can automatically obtain its network parameters using DHCP (Dynamic Host Configuration Protocol). This requires the network to have a functioning DHCP server (for example, a DSL router with activated DHCP server) and the camera must be booted using DHCP (see Section 3.2.6, «Starting the Camera with an Automatic IP Address (DHCP)»). The IP address automatically assigned by the DHCP server will be announced via the camera speaker as soon as the camera has booted successfully.

Benefits

- You can connect the camera directly to the target network.
- Network parameters are automatically assigned.
- No additional software is required.
- You do not need to access the camera software.

Disadvantages

- The camera needs to be physically accessible as you need to press a key on the camera housing to boot it using DHCP.
- Requires a running DHCP server on the network.



3.2 First Images and the Most Important Settings

Once the MOBOTIX camera has been connected to the network, you need to set up the camera's network interface accordingly. This step involves setting up and checking the network parameters of the camera. If your network is already using an IP address in the 10.x.x.x range with a 255.0.0.0 network mask, you do not need to change the camera's network parameters. You can access the camera directly (see [Section 3.2.2](#)). If your network or computer does not use an IP address in the 10.x.x.x range (for example, in the 192 or 172 ranges), you should follow one of the following methods for changing the camera's network parameters:

- **Manual setup in the browser** ([Section 3.2.1](#))
- **Automatic setup using MxControlCenter or MxEasy** ([Section 3.2.3](#) and [Section 3.2.4](#))

Note

We will use a camera with the factory address 10.8.0.99 in the following examples. Replace this IP address with the IP address of your camera. You will find the IP address of your camera on a small sticker on the camera. Make sure that the IP addresses used in the following examples are not already being used by other devices in the network.

3.2.1 Manually Setting Up the Network Parameters in a Browser

You need a computer that is using a 10.x.x.x IP address in order to manually set up the network parameters of the MOBOTIX camera. The computer's network parameters usually have to be changed for this purpose.

1. Change the Network Parameters of Your Computer:

Windows (XP, Vista and 7):

1. Open **Start > Settings > Control Panel > Network Connections**. Clicking on **Properties** opens the dialog box shown.
2. Double-click on **Internet Protocol (TCP/IP)**. On the **General** tab, activate the **Use the following IP address** option. Enter an IP address in the 10.x.x.x range in this field (for example, 10.8.0.11).
3. Once all dialog boxes have been closed, the computer will have the IP address 10.8.0.11.

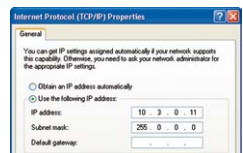
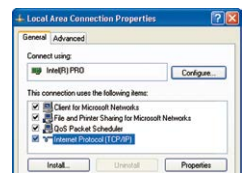

Pressing the "L" key will prompt the camera to announce its current IP address on the camera speaker (see the figure in [Section 2.5.8](#), «Camera Startup Sequence»)

Entry in "Subnet mask" field: 255.0.0.0

Linux/Unix:

1. Open a terminal as `root` user.
2. Enter the following command: `ifconfig eth0:1 10.8.0.11`
3. The computer is now also using the IP address `10.8.0.11`

Mac OS X:

1. Open **System Properties > Network**.
2. Select **Ethernet**. In the **Configuration** field, select **Manual** and enter a 10.x.x.x IP address (for example, 10.8.0.11).
3. Click on **Apply** on the bottom right-hand side of the dialog box to assign the computer the IP address 10.8.0.11.



2. Set Up the Target Network Parameters of the MOBOTIX Camera:

1. Open a web browser on the computer and enter the default IP address of the MOBOTIX camera in the address bar of the browser (for example, 10.8.0.99). Pressing Enter displays the user interface of the MOBOTIX camera (see also *Section 3.2.2, «First Images and the Most Important Settings in the Browser»*).
2. Click on the **Admin Menu** softbutton in the user interface of the MOBOTIX camera. The Quick Installation starts automatically once the *admin* user has logged on.

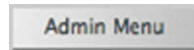

Note: The Quick Installation can also be executed at a later stage by opening **Admin Menu > Network Setup > Quick Installation** (see also *Quick Installation in the Camera Software Manual Part 2*).

3. Enter the target network parameters of the camera on the appropriate page of the Quick Installation assistant.

Note: The network parameters can also be modified retrospectively via **Admin Menu > Network Configuration > Quick Installation**.



4. Once you have completed the Quick Installation and rebooted the camera, the new network parameters will be activated. The camera can now be connected to the target network and, if required, further configured.

Default user data

User name: **admin**
password: **meinsm**

3.2.2 First Images and the Most Important Settings in the Browser

Once the MOBOTIX camera has been connected to the power supply and to the network, you can access the user interface with the live camera image in the web browser. Internet Explorer, Firefox, Safari or any other graphical browser with activated JavaScript is suitable. It does not matter which operating system is used.

After entering the camera's IP address in the browser address bar, you will see the live view of the MOBOTIX camera with its user interface controls, such as softbuttons, buttons for the different camera screens, pull-down menus (Quick Controls), icons for accessing the online help and the camera status, and status information elements.

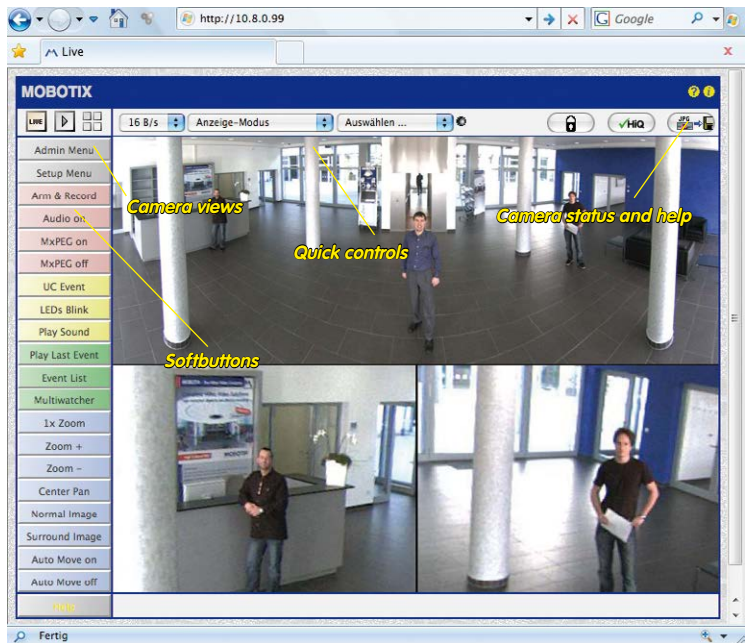

Note

Default access data for the administration menu

- User name: **admin**
- Password: **meinsm**

Camera Views: Live, Player, MultiView

The MOBOTIX camera automatically displays the **live** screen when it starts up (factory default setting). You can set a different start page in **Admin Menu > Language and Start Page** (for example, the **Guest** screen) to allow a restricted access to the live image.

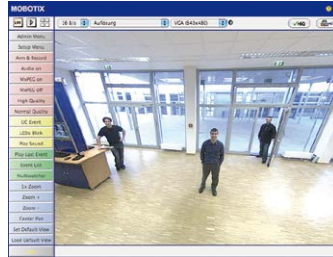

The other available standard screens include **Player** (playback of recorded images and video sequences) and the **MultiView** screen (displays several cameras with live or recorded images).



MultiView allows you to view several cameras via a "proxy" camera (especially useful if you want to access your cameras from outside of the network with reduced bandwidth) and the **PDA** mode provides a special screen for mobile devices.

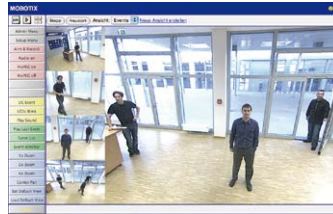

Note

Click on the  icon in the top right corner of the camera's user interface in the browser to find further information on the different camera screens.



Live view:
<http://<camera IP>/control/userimage.html>



Player screen:
<http://<camera IP>/control/player>



MultiView screen:
<http://<camera IP>/control/multiview>

PDA screen:
<http://<camera IP>/pda>

PDA event list:
<http://<camera IP>/control/player?eventlist&pda>

Guest screen:
<http://<camera IP>/cgi-bin/guestimage.html>



3.2.3 First Images and Network Parameter Configuration in MxControlCenter

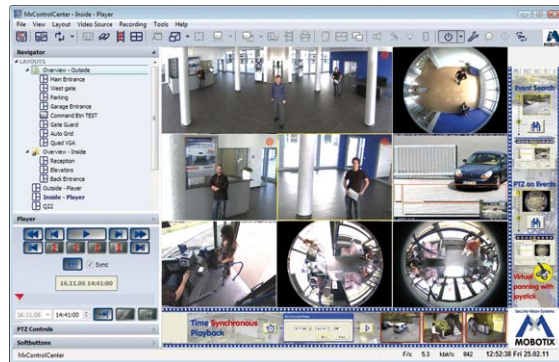

Installation

Download
MxControlCenter
for free from
www.mobotix.com

Download the setup file from the MOBOTIX website to install the latest version. The latest versions are available at www.mobotix.com in the **Support > Software Downloads > MxControlCenter** section.

To install MxControlCenter, simply double-click the setup file and follow the instructions.

The selected files are copied to the computer (older versions will be removed automatically) and the shortcuts are created during the installation process (Desktop, Start Menu, etc.).

Caution

MxControlCenter will automatically attempt to find all MOBOTIX cameras in the physically-connected network (that is, even a MOBOTIX camera with a factory IP address of **10 . x . x . x**). Make sure that the **firewall settings** on your computer are low enough so that MxControlCenter is not blocked. If any MOBOTIX cameras are found, MxControlCenter can **automatically reconfigure** them so that they are available in the current subnet of the computer. If you do not have permission to modify these settings on your computer, contact your system administrator for assistance.

First Images and the Most Important Settings

MOBOTIX– Searching and Displaying Cameras

Launch MxControlCenter after successful installation by double-clicking the shortcut that was created by the installer or the executable file `MxCC.exe` in the installation directory on your computer.

The **Add Video Sources** dialog box appears and the application automatically searches for MOBOTIX cameras in the local network when you launch the program for the first time. Select **Video Source > Add** from the menu to perform a camera search at a later time.

If your MOBOTIX camera is properly connected, it should appear together with the existing video sources in the following list:

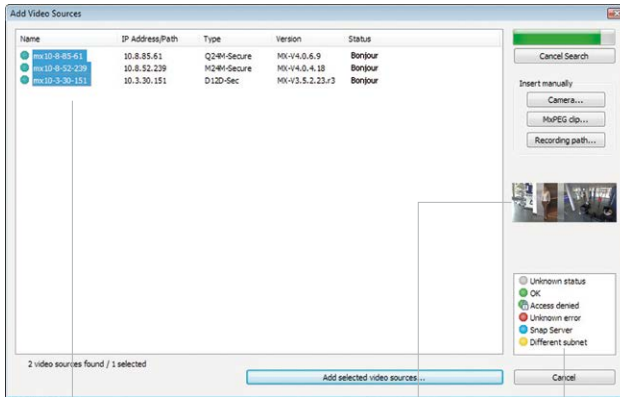

List of video sources

Camera preview



Legend

Automated search for
MOBOTIX cameras

Note

Video sources in this context not only refer to MOBOTIX cameras, but also to third-party IP cameras, file server paths, MxPEG clips and analog cameras connected via MxServer (for example, analog dome cameras). These video sources are not found automatically and need to be added manually.

Cameras Are Found But Are Located in a Different Subnet

The symbols in the first column and the legend in the dialog box indicate whether you can access a particular camera directly from the MxControlCenter, which is the case for all cameras designated with  (**OK**). Cameras designated with  (**different subnet**) are located in a different subnet. This usually applies to new cameras or cameras that have been reset to their factory settings.

Note

MxControlCenter finds all MOBOTIX cameras, even when the computer and the cameras are not located in the same subnet.

Once you have marked all of the desired video sources in the list with **OK**, you can now select the ones that you wish to display and manage in MxControlCenter. The live image is automatically displayed in the preview window when a camera is selected to help you identify the cameras.

For cameras marked with **Different subnet** or if you want to add additional video sources, follow the instructions in the following sections. You can also display the selected cameras directly in a layout. For more information, see section «*Creating a New Layout*».

Reconfiguring Cameras in a Different Subnet

If one or more MOBOTIX cameras are displayed with the status **Different subnet** (for example, cameras with a factory IP address), MxControlCenter automatically offers to configure the network settings of the cameras. In this case, the application displays the dialog box shown here after you have clicked on the "Add selected video sources" button. Click **Yes** to configure the cameras to the subnet of your computer.

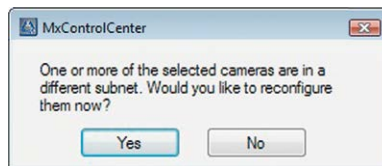

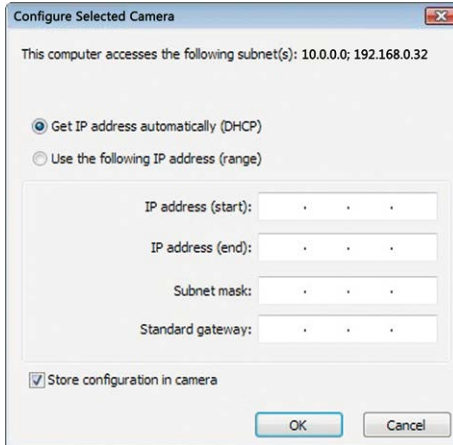

A DHCP server automatically assigns IP addresses for network devices in most networks so that you can automatically select the default setting **Get IP address automatically (DHCP)** in the **Configure selected cameras** dialog box.

Activate the **Use this IP address/this range** option if the IP address of a particular camera must be assigned manually (for networks with static IP addresses). Obtain the assigned IP address, subnet mask and standard gateway from your network administrator and enter the data. All you have to do is enter the range of IP addresses that includes the addresses of all of these cameras to reconfigure multiple cameras at the same time.



Make sure that the **Store configuration in the camera** checkbox is selected. This setting ensures that the cameras are displayed with the correct network settings even after they have been rebooted. Click **OK** to close the dialog box.

Wait until MxControlCenter has changed the network settings and rebooted the cameras. The status of the reconfigured camera changes from  (**Different subnet**) to  (**OK**).

Defining Additional Video Sources

In addition to the MOBOTIX cameras that are found automatically, you can also manually add video sources to the list of video sources for MxControlCenter

- **Camera:** Here, you can enter the known IP address or DNS name of a MOBOTIX camera or a third-party IP camera if it was not found by the automatic search feature.
- **MxPEG clip:** Adds an MxPEG video clip previously recorded by a MOBOTIX camera as a video source.
- **Recording path:** Adds the path of an external file server where a MOBOTIX camera has recorded audio/video data. The videos or images recorded at that location can now be played back using the **Player** or **Video Search**.

Editing the Video Source List

Right-click this list to open a shortcut menu from which you can select all video sources or cancel the selection. You can also use this method to remove from the list some or all of the video sources that you do not want to display or manage in MxControlCenter.

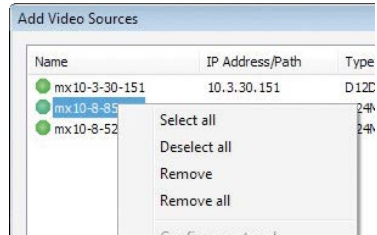

If you have cancelled the camera configuration process or need a password that differs from the camera's factory default password, you can also configure the camera from the shortcut menu at a later date and enter the user name and password required for reconfiguration at that time.

It is also possible to open the **Configure selected cameras** dialog box using the shortcut menu in order to change the camera network parameters.

Creating a New Layout

Select the camera or other video sources that you would like to display in a layout (a view with a group of selected cameras) in the **Add video sources** dialog box and then click **Add selected video sources**.

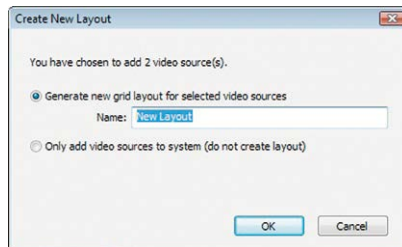

The **Create new layout** dialog box is displayed. If you select the **Generate new grid for selected video sources** option here, MxControlCenter automatically generates a grid layout that displays windows of the same size for all selected video sources. Give each layout a unique name (for example, *Underground garage*).

If you select the second option, the video sources you selected are simply integrated in the MxCC system where you can use them to generate a layout at a later time.

Click **OK** to confirm your selection.

3.2.4 First Images and Network Parameter Configuration in MxEasy

Installing and Starting MxEasy

Download the current version of MxEasy from the MOBOTIX website (www.mobotix.com > **Support** > **Software Downloads** in the **MxEasy** area). Double-click the shortcut for the program or the program file.

Finding Cameras

When you start MxEasy for the first time on a computer, the MxEasy Wizard automatically begins to search for MOBOTIX cameras and displays all the cameras found in a list. The camera list will be updated automatically as soon as new MOBOTIX cameras are connected to the local network or removed from the network.

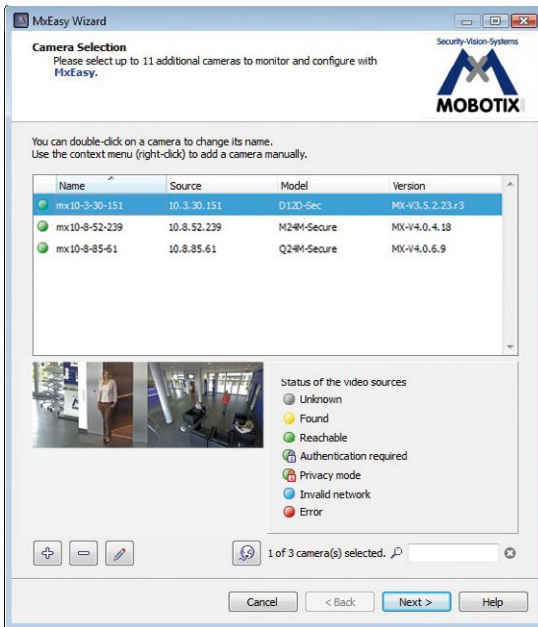

MxEasy also automatically monitors and displays the operating status of all cameras. Cameras that are not on the same subnet as the computer will get a differently colored symbol than the cameras that are on the same subnet. Likewise, the cameras that have an unknown password or for which no user name/password combination has been specified in MxEasy will be displayed in a different color. The following section contains information for cameras with the status **Invalid network** (for example, for all new MOBOTIX cameras with factory settings) and includes tips for configuring the cameras for the "right" subnet.



Download MxEasy for free from www.mobotix.com

*Bonjour: automatic recognition of network services in IP networks

Reconfiguring Network Addresses of Cameras

Using Bonjour*, MxEasy not only finds cameras on the same network as your computer, it also finds MOBOTIX cameras located in other subnets (status **Invalid network**). In such a case, you would not be able to establish any connection to cameras in a different network or subnet (without going into much further detail regarding TCP/IP network configurations). This is possible, for example, when a camera with a factory IP address is connected to a network in which a DHCP server automatically assigns the IP addresses. MxEasy can automatically configure such a camera so that it is "integrated" into your existing network. To do so, you only have to select the affected camera in the list and then click **Continue**.

After a security prompt, a new dialog box for configuring the selected camera is displayed.

The camera "m12 - cki" with IP address "10.4.7.204" has not been set up correctly for access from within your local network.
Would you like to change the network configuration of the camera now?

Get IP address automatically
 Apply to all selected cameras

Use the following IP address

IP address: 192.168.30.*
Subnet mask: 255.255.254.0

This computer accesses the following subnet(s): 192.168.30.0, 10.37.129.0, 10.211.55.0

Cancel OK

If your computer automatically obtains its IP address from a DHCP server, then this is certainly the best choice for that specific camera and most likely for all other cameras that have been found in a different subnet (**Get IP address automatically** option).

If you have assigned a static IP address to your computer, you will probably want to assign static IP addresses (issued by your system administrator) to every camera (the **Use this IP address** option). Normally, you enter the same configuration used for the network settings of your computer.

When you click **OK**, the selected cameras are automatically reconfigured and they are located in the same subnet as the computer.

Integrating and Displaying Cameras

After a camera has been reconfigured, it has the status **Accessible** and can be integrated into MxEasy. The MxEasy Assistant then displays the **Define integration mode in MxEasy** dialog box.

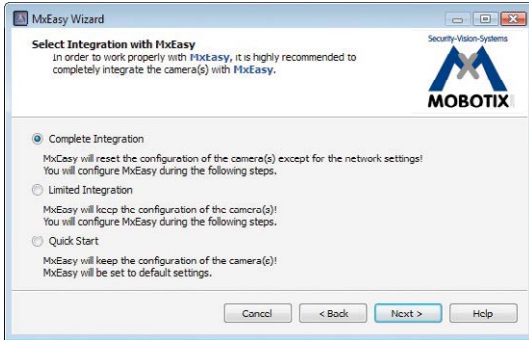

Here, you can jump directly to the main window of MxEasy with the current live camera image by activating the option **Quick Start**. However, some required detailed configurations may have to be made at a later time (for example, password protection, available bandwidth). For this reason, we recommend activating the option **Complete integration** and complete the remaining dialog boxes of the MxEasy Assistant until the main window appears.

If one of the integrated cameras includes a **S15D**, the MxEasy Assistant opens an additional page where you can specify the **mounting positions** (*Ceiling, Wall, Floor*) and **display modes** (*Panorama, Surround, etc.*) of the individual sensor modules.

After you are done with the MxEasy Assistant, the application's main window appears and displays the first camera:

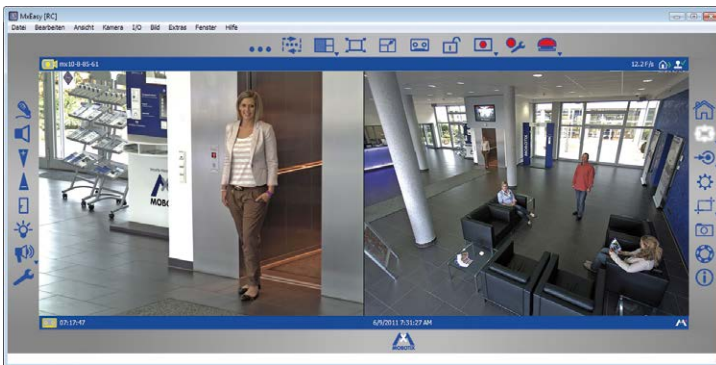

Main window with dual image display of a S15 (telephoto lens and wide angle)

For more information, see the **MxEasy User Manual**, which can be downloaded as a PDF file from the MOBOTIX website: www.mobotix.com > **Support** > **Manuals**.

Passwords and camera settings will not be changed

3.2.5 Starting the Camera with the Factory IP Address

Under certain circumstances, you may have to reset the camera to its factory IP address. This could be the case, for example, if the IP address has been lost or the camera does not respond to the last known IP address. Proceed as follows to start up the camera with its factory IP address:

1. If the camera is powered on, disconnect the power supply by unplugging the corresponding cables and then reconnect the power supply.
2. Wait until both LEDs light up simultaneously for the first time.
3. **Press the L key within the next four seconds and hold it down until the LED next to the key is blinking three times** (if you need to try again, go back to Step 1).



4. If a speaker is attached to the camera, the camera emits a single sound ("boing") after about 30 to 45 seconds.

The camera has finished booting and can now be used (e.g., MxEasy, MxControlCenter, MOBOTIX App, web browser).

Notes

If you use the camera's **L key** to load the factory network configuration, this configuration is not automatically saved in the camera's flash memory. When the camera is next rebooted without using the **L key**, the last stored network configuration will be used. To permanently store the new network configuration in the camera's flash memory, open **Admin Menu > Store**.

As opposed to resetting the camera using **Admin Menu > Reset configuration to factory defaults**, the user information will **not** be reset if the camera is booted using the factory IP address.

Make sure you store the default network configuration to the permanent flash memory!

3.2.6 Starting the Camera with an Automatic IP Address (DHCP)

If your network has a DHCP server, you can start the MOBOTIX camera with DHCP support. The camera automatically obtains an IP address from the DHCP server and announces the new network data. Please note that this announcement can only be heard if the camera is connected to an external speaker.

1. If the camera is powered on, disconnect the power supply by unplugging the corresponding cables and then reconnect the power supply.
2. Wait until both LEDs light up simultaneously for the first time.
3. **Press the R key within the next four seconds and hold it down until the LED next to the key is blinking three times** (if you need to try again, go back to Step 1).



4. If a speaker is attached to the camera, the camera emits a double sound (“boing, boing”) after about 30 to 45 seconds.

The camera has finished booting and can now be used (e.g., MxEasy, MxControlCenter, MOBOTIX App, web browser).

Notes

Starting the camera with an automatic IP address (DHCP) is only **temporary**. The network configuration of the camera can be permanently set to DHCP under **Admin Menu > Ethernet Interface**.

Make sure that the network has a functioning DHCP server when starting the camera with DHCP support. If this is not the case, the camera cannot obtain a valid IP address and will use its last IP address.

You should also make sure that the cameras always obtain the same IP addresses by permanently assigning the MAC addresses of the cameras to the desired IP addresses.

In case of an error, the camera uses its last IP address!

3.3 Adjusting Lens Focus and Inserting a Filter

3.3.1 Adjusting Lens Focus (L65-L76/L135-L160 Only)

Once the camera has been installed, the L76 and L160 sensor modules should be checked for proper image sharpness and manually adjusted, if required. To do so, use the blue lens wrench and the black module wrench (both are supplied with the S15 basic module).



Procedure

1. Position the blue lens wrench on the notches of the sensor module. Rotate the wrench **to the left** until you feel a stop (max. 300°) and then a little bit further until the protective glass lens slides out of the sensor module.
2. Adjust the image sharpness according to the camera's live image on the computer monitor. To do so, position the black module wrench (with the ring-pattern side) on the lens and carefully rotate to the right or left. **Do not turn the lens too far or with force to avoid damaging the image sensor.**
3. If required, clean the inside of the protective glass lens using a clean, lint-free cotton cloth.
4. Place the protective glass lens on the notches of the blue lens wrench.
5. Position the protective glass lens with its clips (red arrow on the image in the margin) and firmly press onto the sensor module. Rotate the glass **to the right** using the blue lens wrench until you feel a stop.
6. If required, clean the outside of the protective glass lens using a clean, lint-free cotton cloth.



The focusing aid provides a visual aid when correcting the image sharpness (see *The Live Screen of the MOBOTIX Camera* in the camera's online help).

3.3.2 Inserting a Filter

MOBOTIX offers a polarization filter in its range of accessory products for all sensor modules (except for L10-L12 and L270-L320). The polarization filter prevents unwanted reflections from smooth surfaces. The filter can be used to provide better facial recognition of the people behind the windshield of a car, for example. Only one filter can be used per sensor module, which then replaces the standard protective glass lens.

Procedure

1. Position the blue lens wrench on the notches of the protective glass lens. Rotate the wrench **to the left** until you feel a stop (max. 300°) and then a little bit further until the protective glass lens slides out of the sensor module.
2. If required, clean the inside of the filter using a clean, lint-free cotton cloth.
3. Place the filter on the notches of the blue lens wrench.
4. Position the filter with its clips over the two receptacles on the sensor module (red arrow on the image in the margin) and firmly press onto the sensor module. Rotate the glass **to the right** using the blue lens wrench until you feel a stop.
5. Adjust the **polarization filter** according to the camera's live image on the computer monitor. Rotate the filter to the left using the blue lens wrench until you reach the desired setting (maximum 180°).
6. To readjust the polarization filter, rotate it back **to the right** until you feel a stop and repeat step 4.
7. If required, clean the outside of the filter using a clean, lint-free cotton cloth.



Note

Note that using the **polarization filter** reduces the amount of light that enters the lens by approximately 50%.

3.3.3 Replacing the Dome Against the Sealing Ring (Only Sensor Modules L10-L12)

For special scenarios with hemispheric sensor modules, e.g., if light entering from the side creates reflections within the dome, you can use the sealing ring instead of the dome (order no. MX-OPT-Ring-L10-L12).

To exchange the dome against the sealing ring, use the blue lens wrench supplied with the S15D basic module.



Caution

In order to avoid burns by the hot lens, the sealing ring must not be installed if the sensor module is within the reach of persons!

Procedure

1. Insert the blue lens wrench into the notches of the dome. Rotate the wrench **to the left** until you feel a stop (max. 300°) and then a little bit further until the dome slides out of the sensor module. When doing this, make sure that the dome does not get stuck in the sensor module housing.
2. Turn the wrench over, insert the two notches into the slots of the lens' metal ring and unscrew the lens until you can remove it from the sensor module.
3. Insert the lens into the sealing ring as shown.
4. Fully insert the lens into the sealing by pressing firmly on two sides of the lens, until the metal rim of the lens is on the same level as the sealing.



5. Screw the lens with the sealing ring back into the sensor module using the blue lens wrench.



6. Adjust the image sharpness according to the live image on a computer monitor. Use the blue lens wrench for this purpose and turn the lens cautiously to the left and to the right. ***Do not turn the lens too far or with force to avoid damaging the image sensor!***



3.4 Virtual PTZ and Full Image Recording

3.4.1 Preparing the Virtual PTZ Function

The virtual PTZ function allows you to use a mouse or joystick to continuously zoom in on images from the selected video source and “virtually” move the enlarged image section within the entire image sensor area.



Greater ease of use
through a joystick

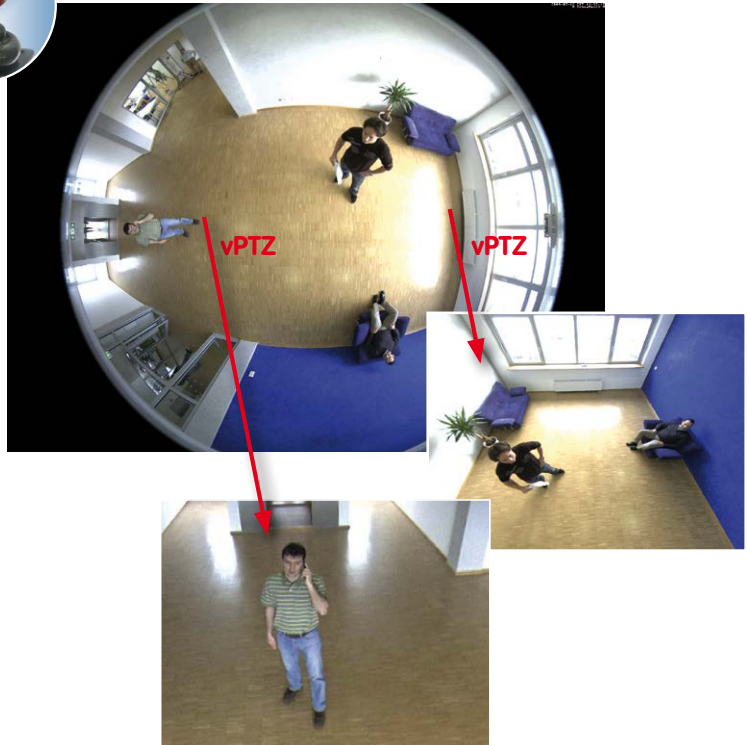

Operation Using the Mouse and Scroll Wheel

The vPTZ function of the S15 can be controlled in the browser using the mouse. This position becomes the new image center by clicking on any position on the image displayed on the monitor. The image moves accordingly and the image distortion is automatically corrected. The **scroll wheel** can be used to control the zoom function. This functionality is disabled in the default settings of the camera and must therefore first be activated. To do this, go to **Setup Menu > vPTZ Settings**, disable **Lock Mouse Wheel Zoom**, click on **Set** and then on **Close** to save your settings. You can now use the scroll wheel to zoom + (roll upwards) or zoom - (roll downwards).

Operation Using a USB Joystick

A standard USB joystick can drastically improve vPTZ operation for the user – in the browser, in MxEasy, and in the MxControlCenter (however, MxCC is also equipped with a virtual joystick that can be operated using the mouse). Please first install the joystick on the PC according to the manufacturer's instructions.

In order to use a USB joystick in the browser, make sure that you have a PC with a Windows operating system and the latest version of Internet Explorer and that the **“ActiveX” mode in the camera software (browser) is activated:**

- Switch to **Browser** in the Quick Control.
- Under **Browser**, select the option **ActiveX** in the field to the right. The USB joystick can then be used until the browser is closed.
- To store the setting permanently, ActiveX must be activated in the **Admin Menu**. To do so, use **Language and Start Page** in the Admin Menu.
- Under the page options, select the **ActiveX** operating mode.
- Store the settings permanently in the camera by clicking on **Set** and **Close**.
- The joystick can now be used.

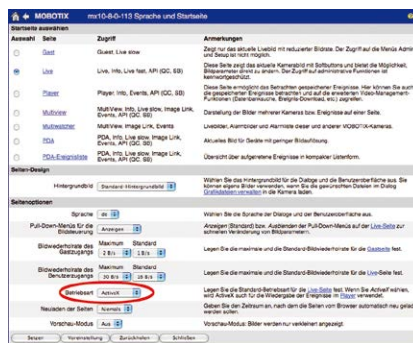
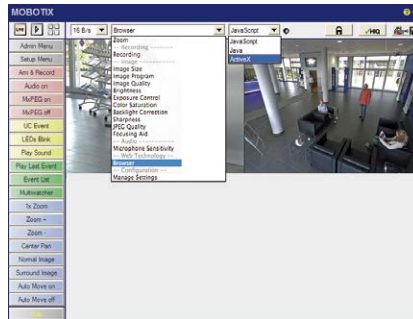

Notes

You will find more information and details on vPTZ in the **Camera Software Manual Part 2, Section 4.3.6, «Virtual PTZ»**, the **MxEasy** manual, **Section 2.4.1, «Activating the PTZ Features»**, the **MxControlCenter** manual, **Section 2.4.6, «Using the vPTZ Features»** and **Section 3.1.4, «The “PTZ Controls” Section In The Sidebar Panel»**.

Current versions of all manuals can be downloaded anytime from the MOBOTIX website www.mobotix.com under **Support > Manuals**.

3.4.2 Full Image Recording

It is possible to record a **full image**, regardless of the live image stream that is being displayed. This ensures that the recording always contains the full image of the lens used, even though the operator may have used the vPTZ features to zoom into the image in order to examine a specific detail.

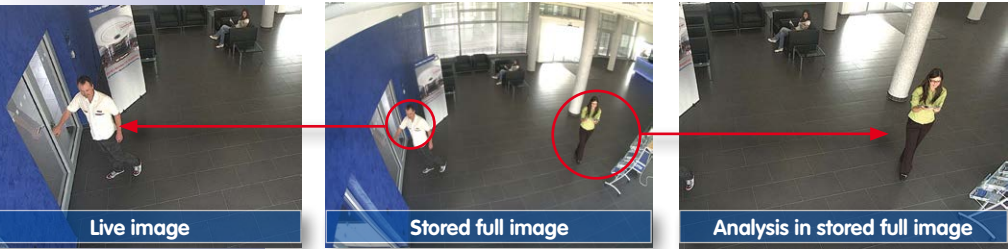

Stored full image:
Original camera image
without distortion or
image correction

This means that you can use the vPTZ features in VGA resolution to pan, tilt and zoom in the live image while the camera is, for example, recording full images at 1 fps in MEGA or QXGA resolution.

In **MxEasy** and **MxControlCenter**, the recorded full images may be prepared for the user with the vPTZ functions (for example, panning and zooming in on an image detail such as a doorway).

If **full image recording is not activated**, only the last displayed live image will be saved (save what is seen). The **main benefit** of live image storage is to ensure that the full power of the camera processor is used for live image correction and maximum frame rates. The **main advantage of full image recording** lies in the special functionality of the S15, in that it can always maintain availability of a maximum size (full) image for later investigation, despite vPTZ actions carried out on the live image. The mechanical limitations of motor-driven PTZ cameras mean that they simply **cannot** provide this unique advantage to the user!

Notes

Post-event search in the full image: If you are using full image recording on S15 cameras, you should use at least MEGA resolution when storing. This will facilitate later searches in **MxControlCenter** or **MxEasy**. The advanced distortion correction features require this function to deliver satisfactory image quality.

Full image recording on: Due to the increased processing time, full image recording reduces the data rate of the live image stream, which may drop by around 10 to 30 percent. We therefore recommend reducing the frame rate for storage as much as possible to affect the live image stream as little as possible.

Full image recording off: The event that triggered a video motion (VideoMotion VM) window may not be in the recorded sequences while the window was not displayed at the time.

Activate/Deactivate Full Image Recording in the Browser

To configure this feature, open the **Setup Menu > Event Control > Recording** dialog box and activate or deactivate the **Full Image Recording** option.

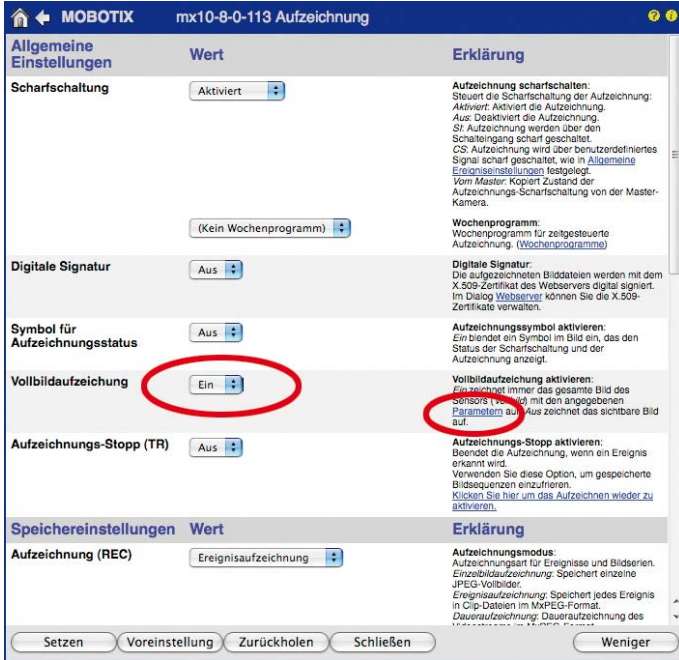

3.4.3 Special S15 Configuration in the Browser

The MOBOTIX S15M and S15D with one or two D10/N10 sensor modules offer a range of special configuration options for the image settings due to their hemispheric lenses. Depending on where the camera is mounted (ceiling, wall or floor) and on the live image display preferred by the user, certain important basic settings and, if necessary, their adjustment must be configured when a S15 is first installed.

A corresponding adjustment of the image setting is strongly recommended if one or both of the sensor modules of a S15D were mounted using a 15° wedge (available as an accessory).

S15D and Different Sensor Modules

A range of combination options are provided that change the available display modes and configuration possibilities by using the MOBOTIX S15D with different sensor modules.

Because of this, a S15D automatically detects which sensor modules are installed and proceeds as follows:

- When the camera is started for the first time, it detects the connected sensor modules and captures their data (focal length, day or night version).
- If only one sensor module is connected, the camera acts as a single-lens camera (meaning that there is no automatic day/night switching, etc.).
- If there is no change within the first 12 hours of operation, the camera writes the details of these sensor modules to the camera configuration.
- With every restart, the camera checks if the stored sensor modules are present. If any changes are detected, **the camera indicates these through a corresponding alert in the live display.**



Configuring the LEDs on an S15D

Because the LEDs on a S15D are located not only on the camera but also on the sensor modules, they can be configured separately for the camera and each sensor module (**Admin Menu > LED Setup**).

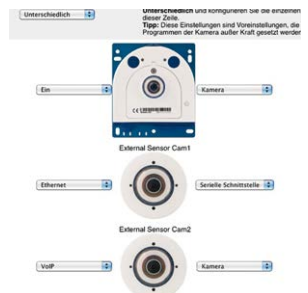

Virtual PTZ and Full Image Recording

Characteristics of an S15M

A S15M can only be fitted with an L12 lens due to design considerations. Because of this, a S15M acts the same as a **Q25M Hemispheric**. It allows the same types of installation (ceiling, wall, floor) and provides the same display modes.



Configuration of the S15 Basic Parameters

Complete the steps described below in the browser window:

1. **Log onto the camera and boot it** as described in *Section 3.2*.
2. **Select mounting position wall/ceiling/floor**: Click on **Installation** in the Quick Control panel and then select **Wall**, **Ceiling** or **Floor** according to the mounting position of the camera. **Ceiling** always means that the orientation of the camera or sensor module is from **top to bottom** and for **Floor**, the camera or sensor module's orientation is from **bottom to top**.

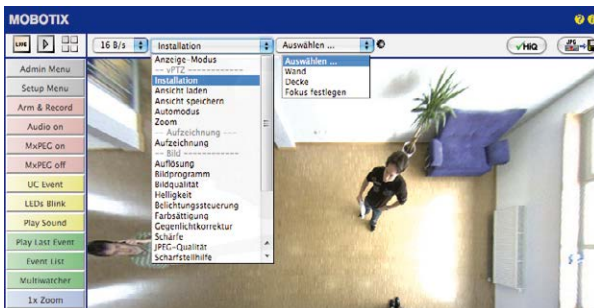

When you are setting up a S15D with two sensor modules, specify their mounting positions separately in the **Installation (right)** and **Installation (left)** Quick Control fields for the right and left sensor modules (i.e., camera images) respectively.

As a result, you will get a **perspective-corrected panorama view** for each image sensor matching the specified mounting position. Panorama view is set as a factory default and it can be changed as described below.

3. Switch to the **Display Mode** Quick Control.
4. Set the mode that you want to be the standard view. For demonstration purposes, the descriptions below describe the typical display mode for the wall mount and the ceiling mount, **Panorama** and **Surround** respectively. Every other display mode can be operated in the same way.



Left and right camera images from two sensor modules (S15D)

Camera live image with
panorama correction

Wall-Mounted: Setting and Correcting the Standard View „Panorama“



High-resolution 180° panorama
ΗΙΨ-ΛΕΞΗΨΙΨΙ 180. ΒΑΨΙΟΛΑΨΑ

1. In the **Display Mode Quick Control**, select the option **Panorama**. Examine the image that is now displayed. If the section meets your expectations, no further adjustment is necessary, and panorama configuration is complete. To change the image section to meet your specific expectations, continue with Step 2.

Camera live image
without **MOBOTIX**
panorama correction with
Quick Controls visible

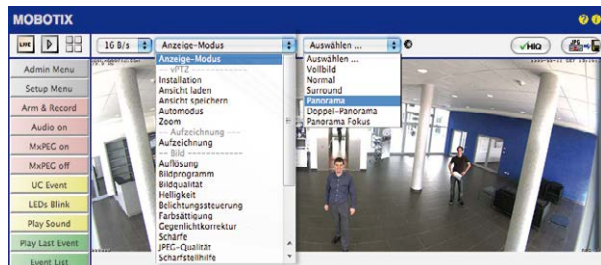

Note

The currently visible image section may differ from the desired image section due to the installation position or any accessories in use, for example. However, it is not necessary to physically move the camera, as in this case the browser alone can be used to adjust the visible panorama image by zooming, panning and tilting. Tilted vertical lines may also be optically straightened to the image edges using the panorama correction function. These tilted lines are primarily caused if the camera or sensor module is tilted (for example, due to mounting with 15° wedges) or if the image tilt is modified.

- Click on the **lock icon**. Clicking on the lock once opens it (lock clasp is raised). The lock prevents execution of later vPTZ actions, which could also unintentionally modify the view you configure. This holds for all overview display modes, that is, also for Panorama/Focus, Double Panorama and Surround.



Open lock

- A new **icon for processing the panorama image** appears in the top left corner of the camera image. Enlarge the image by clicking on the icon once (OnScreen Control appears).



Click on the icon

- Using the **OnScreen Control** visible in the live camera image, you can now change the displayed live camera image as desired (panning, tilting, zooming, rotating and panorama correction; see fig. on the right). When doing so, the vPTZ function using the mouse or joystick is deactivated. In case of a S15D with two sensor modules, click on the corresponding camera image (right/left) to edit it (highlighted with a yellow frame).

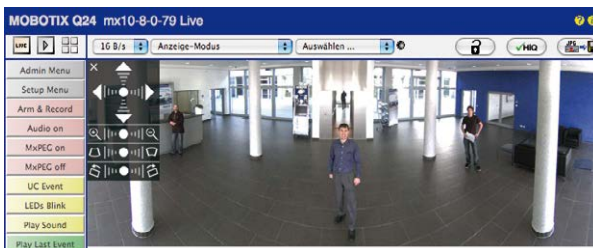

Camera live image with panorama correction with OnScreen Control visible

- After you have modified the desired setting, close the control panel (x in the top left hand corner).
- Click on the lock icon again** to close it (lock clasp is down). The panorama image setting is then locked until the camera is next restarted.

Caution

To permanently save the standard image setting defined for the S15 go to the **Store Complete Configuration** option in the **Manage Settings** Quick Control. The settings will then remain in effect, even after rebooting.

Functions Of The S15 OnScreen Control

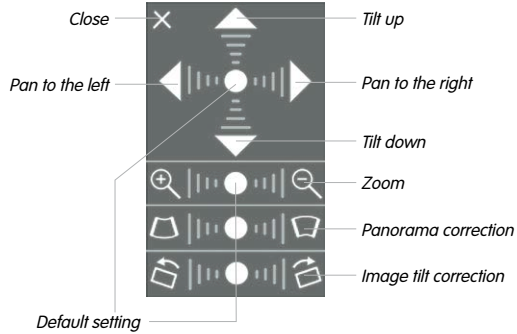

Depending on the mounting position (ceiling, wall, floor), panorama correction and mounting error correction may not be available!

To use the OnScreen Control, click on the arrows in the top area for shifting the image section. In the bottom areas, which are displayed when needed, click to the left and/or right of the center point.

The same applies for every area: **The further away that you click from an area's center point, the greater the change triggered.** To reset an area, click on its center point again.

During panorama correction, clicking between the two trapezoid symbols straightens the left or right tilting lines, which are best visible at the edges of the image section.



Bring columns together at the top (necessary to correct the example on the left)

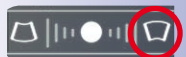

Bring columns together at the bottom



Ceiling-Mounted: Set North (User-Defined North Direction)

Once a sensor module (S15D) or entire camera (S15M) is mounted on a ceiling, you need to specify its North direction. This is not the “true” direction of North but rather the **main line of sight or the focus** of the camera or sensor module. It serves as a reference for the North direction in the **Surround** and **Double Panorama** display modes (the **Ceiling** option was already selected in the **Installation Type** Quick Control).

1. In the case of a double image, click on the corresponding sensor module (camera image) and select the **Normal** option from the **Display Mode** Quick Control.



2. **Rotate the live image** in the desired direction using the mouse or a joystick connected to the computer.

For vPTZ use and the configuration of a USB joystick, see Section 3.4.1



3. In the **Installation Quick Control**, select the **Set North** option.

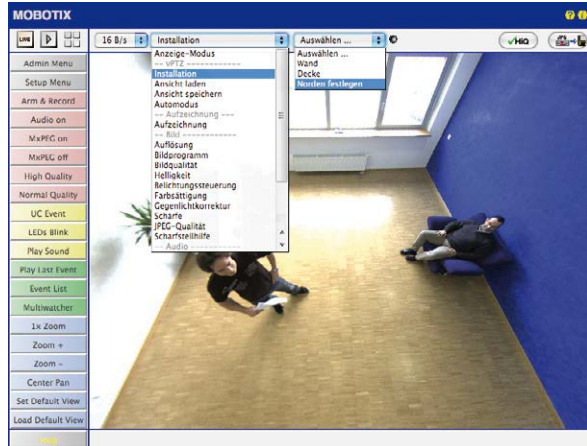

4. Store the desired North direction permanently by first activating the checkbox and then clicking on **Yes**.

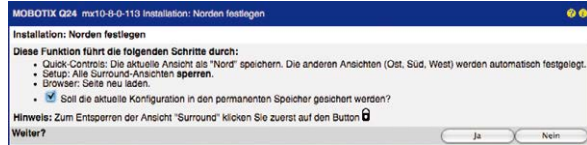

5. You have now set the North direction for the **Surround** and **Double Panorama** display modes. In the next step, you can set these views as the standard view for the camera live image.



Caution: No OnScreen Control is available in "Double Panorama" mode

In the **Display Mode** Quick Control, select the option **Surround or Double Panorama**. You can fine-tune the views using the vPTZ via mouse or joystick and, as described above, by unlocking and locking the standard view using the lock icon (open lock, correct display and close lock again).

Note

For each of the **subviews** (*North, East, etc.*; see below), the **OnScreen Control** on the side can be used to adapt it (open lock, click on subview, adapt view, click on next subview, adapt view and close lock again).

Camera Images and Subviews of Camera Images

The ability of the S15D to operate multiple sensor modules means that in double image display, the live image's **camera images** (left, right) can be used for differing display modes. Depending on the display mode selected for each camera image, this may be divided into **subviews**:

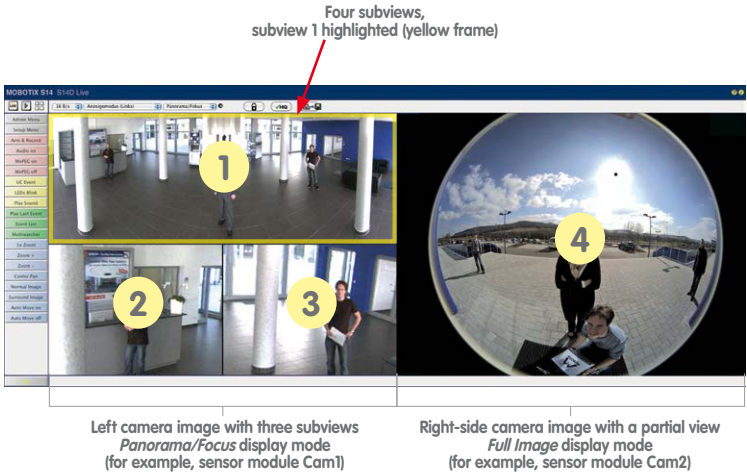

When you click inside one of the subviews, this area is highlighted with a yellow frame. All of the PTZ actions triggered by the mouse, joystick or OnScreen Control now only apply to the highlighted subview.



Sensor Configuration (S15D Only)

Sensor configuration specifies which sensor module is connected to which of the camera's connections (**Cam1** or **Cam2**), and in which camera image (left/right) the sensor module is to appear for the dual image display. Open the corresponding dialog box here: **Admin Menu > Sensor Configuration**.



You should also open the **Sensor Configuration** dialog box in the following cases:

- **Swapping the displayed camera images:** You wish to display the left camera image on the right (and vice versa) without having to replug the sensor module cables on the camera itself.
- **Replacement of sensor modules:** In this case, the S15D detects after startup that the sensor modules have been replaced and indicates this through an alert superimposed on the live image as well as through a system message (**Admin Menu > System Messages**).
- Adding/switching on sensor modules: This is where you can re-enable deactivated modules.
- **Removing/switching off sensor modules:** This is where you can deactivate any connected modules if needed.

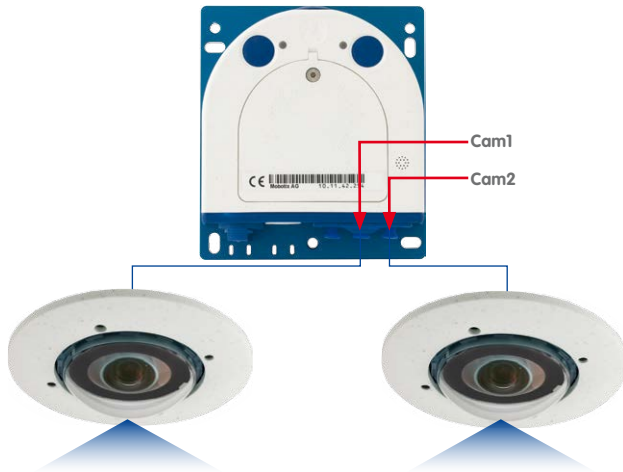

Configuration of Audio Settings

Thanks to the MOBOTIX S15 system's flexible layout, there are a number of different microphone options depending on the model used (S15D, S15M).



Information on how to connect external microphones and speakers is provided in Section 2.2.8, «External Audio Support (Microphone/Speaker)».

Microphones for the S15D:

With this camera, you can either use an external microphone or the connected sensor modules' built-in microphones (or just one of these). If the microphones of both sensor modules are used, the camera records the sound of both microphones to a single audio track.

Microphone for the S15M:

You have to use an external microphone with this camera.

Speaker (S15D, S15M):

As neither the S15D nor the S15M features a built-in speaker, this function can only be used to activate/deactivate an externally-connected speaker.

More robust than hard drives: flash drives for recordings

3.5 MicroSD Card Recording

3.5.1 Introduction

Flash-based storage devices (MicroSD cards, USB flash drives and solid-state drives) do not contain any moving parts as compared to the commonly used hard drives. Flash-based storage devices are compact and highly resistant to moisture and vibrations. They feature low energy consumption and they do not lose any data in the event of a power failure, meaning that they are ideal for use with MOBOTIX cameras.



Number of Write/Delete Cycles Per Flash Storage Cell

The number of write/delete cycles of every storage cell of a flash device is limited. The controller of the flash device automatically detects individual flash cells that are no longer functioning. The contents of the faulty cell will then be rebuilt using a checksum and will be moved to a properly working spare cell. The faulty storage cell will be marked as “bad” and will no longer be used. No data is lost in this process.

In addition, MOBOTIX cameras can constantly monitor activated flash storage devices. MOBOTIX has developed a technology to test the wear of the flash device by logging the number of write/delete cycles (patent pending). The flash memory wear is automatically displayed in the status bar in the live camera image but it can also be viewed at any time in the **Admin Menu > Camera Status** dialog box.

Low Memory Usage Thanks to MOBOTIX MxFFS File System

MxFFS formatting of the MicroSD card means that MOBOTIX camera software will use the flash device as evenly as possible, thus allowing for the maximum possible number of write/delete cycles. This also means that all storage cells of the flash device will be written and deleted with the same frequency, if possible. MOBOTIX technology increases the life of the flash device considerably and also improves the security and the reliability of the storage process.

Storage Requirements And Life Expectancy Of MicroSD Cards

The life expectancy of a MicroSD card increases proportionally to the storage capacity, since the camera software will execute fewer write/delete cycles on each storage cell. The first deletion will begin once the SD card has been filled to capacity (first full cycle).

All specifications are based on calculated averages

32 GB MicroSD Card: Storage Requirements					
	6 fps CIF	6 fps VGA		1 fps MEGA	1 fps QXGA
	M-JPEG	M-JPEG	MxPEG	M-JPEG	M-JPEG
File size single image	15 kB	45 kB	–	120 kB	240 kB
Storage required per second	90 kB	270 kB	75 kB	120 kB	240 kB
Storage required per 24 hrs	7.8 GB	23.5 GB	6.5 GB	10.4 GB	20.8 GB
Time for one full cycle	4 days	1.3 days	4.8 days	3 days	1.5 days

4 GB MicroSD Card: Storage Requirements					
	6 fps CIF	6 fps VGA		1 fps MEGA	1 fps QXGA
	M-JPEG	M-JPEG	MxPEG	M-JPEG	M-JPEG
File size single image	15 kB	45 kB	–	120 kB	240 kB
Storage required per second	90 kB	270 kB	75 kB	120 kB	240 kB
Storage required per 24 hrs	7.8 GB	23.5 GB	6.5 GB	10.4 GB	20.8 GB
Time for one full cycle	12 hours	4 hours	14.4 hours	9.2 hours	4.4 hours

Caution

The MicroSD card's service life depends on production quality and frequency of use. Set the type of recording (event-controlled or continuous recording, frame rate, resolution) according to your specific requirements.

We recommend changing the pre-installed, high-quality MicroSD card once a year if you have it constantly set to continuous recording.

Monitoring the Cell Wear of Flash Storage Devices (Patent Pending)

MOBOTIX uses its own technology for this purpose and has a pending patent. You can view the flash wear in the status bar of the live image or by opening **Admin Menu > Camera Status**. In addition, the camera can also send a warning message (for example, via e-mail) as soon as a critical error is detected when data is written to the SD card (**Admin Menu > Error Notification Function**.). The MicroSD card can then be replaced to ensure that any existing data is not lost.

File Server / Flash Device	
Type	SD Flash Card
File System	MxFFS
Flash Wear	1%
Transfer Buffer Usage	0% (0: 0%, max: 0%)
Lost Event Images	0
Sequences	1 (1 files)
Newest Sequence	1970-01-01 01:00:00 #0
Oldest Sequence	1970-01-01 01:00:00 #0
Current Usage	4.0 MBytes (0.4%)
Max. Size	936 MBytes

Format SD card:
**Admin Menu > Storage
 on External File Server
 / Flash Device**

The **Secure deletion – Slow** option takes several hours. You can also use suitable applications on Windows, Linux/UNIX and Mac OS X systems to repartition and safely erase the SD card.

3.5.2 Formatting the MicroSD Card

Before a MOBOTIX camera can store image and video sequences on a MicroSD card, the card needs to be formatted as MxFFS (MicroSD cards supplied by MOBOTIX are already MxFFS-formatted). The following steps are necessary to format a storage device (**Admin Menu > Storage on External File Server / Flash Device**):

1. Make sure that there is a MicroSD card in the card slot of the MOBOTIX camera.
2. Click **Format** in the **SD Memory Card**

3. Note down the characters shown in the **Encryption password** field or enter your own password. Next, click **OK**.

Note: The **Secure deletion – Slow** option will ensure that any data on the MicroSD card is overwritten completely so that the data cannot be recovered in any way. However, keep in mind that this kind of safe formatting takes considerably more time.

4. In the next dialog box, enter the user name and the password of a user of the **admins** group and click **OK** to confirm.

The MOBOTIX camera now starts formatting the card. It takes 5 to 12 minutes to format an 8 GB MicroSD card if the **Secure deletion – Slow** option is disabled. If **Secure deletion – Slow** is enabled, this may take anywhere between 3 and 14 hours.

Once the formatting has been completed, you can activate the MicroSD card for recording (see next section).



Caution

Make sure that you always wait until the formatting process has been completed before accessing the camera again. If the **Secure deletion – Slow** option is disabled, this usually takes just a few minutes. You can only access the MicroSD card once MxFFS formatting has been completed.

Formatting with the **Secure deletion – Slow** option enabled takes several hours. You can also use suitable applications on Windows, Linux/UNIX and Mac OS X systems to repartition and safely erase the MicroSD card.

3.5.3 Activating MicroSD Card Recording

Follow these steps to activate the recording to a MicroSD card that has already been MxFFS-formatted (**Admin Menu > Storage on External File Server / Flash Device**):

1. Make sure that there is a MicroSD card in the card slot of the MOBOTIX camera.
2. Make sure that the MicroSD card is formatted in MxFFS format.
3. Activate the **SD Memory Card** option.
4. Click **Set** and then **Close** to store the configuration.
5. Reboot the MOBOTIX camera (**Admin Menu > Reboot Camera**).

Once the camera has rebooted, make sure that the camera displays the **FR REC** symbols in its live image. If this is the case, the camera uses the MicroSD card as recording target. If not, you must activate the recording (see below).

Activating the Recording

If the **FR REC** symbols are not visible in the live image after rebooting, you need to activate the recording using one of the following methods:

- **In the web browser:** Automatic activation by clicking on the **Arm & Record** softbutton. Confirm this in the Easy Dialog by clicking on the **Yes** button.
- **In the web browser:** Manual activation via the Quick Control **Recording > Recording On** or in **Setup Menu > Recording**.
- **MxEasy:** It is possible to activate the recording based on the time or date using the Alarm Planner of MxEasy (see *MxEasy User Manual*).

Encryption and Authentication

All video data stored on the MicroSD card is encrypted to ensure security at all times. The password for this is defined during the card's formatting procedure and needs to be entered for authentication whenever the recordings are accessed (see next section).

Activate recording:
**Admin Menu > Storage
on External File Server
/ Flash Device**

3.5.4 Accessing Data on the MicroSD Card

The following options facilitate access to the stored image and video sequences on a MicroSD card:

- **In the web browser:** Play back the recorded event images without sound directly from the MicroSD card using the Playback view of the camera software.
- **In MxEasy:** Play back the recorded video sequences with sound by accessing the MicroSD card in the MOBOTIX camera via the camera.
- **In MxControlCenter:** Play back the recorded video sequences with sound by accessing the MicroSD card in the MOBOTIX camera via the camera or by directly accessing the MicroSD card via a card reader connected to the computer. Access the card by setting the MicroSD card's drive/volume as a **Directory** in MxControlCenter.

If the recordings stored on the MicroSD card were encrypted, you need to enter the password used for the encryption before you can access the data. If this is the case, both MxControlCenter and MxEasy will provide a dialog box for this purpose.

Caution

When **using the MicroSD card from one MOBOTIX camera in another MOBOTIX camera**, you need to make sure that the time on the original camera is in sync with the new camera. We recommend using automatic time synchronization via a time server (**Admin Menu > Date and Time**).

3.5.5 Deactivating Card Recording

Follow these steps to deactivate recording to a MicroSD card (**Admin Menu > Storage on External File Server / Flash Device**):

1. Activate the **None** option.
2. Click on the **Set** button at the bottom of the dialog box and then **Close**.
3. Reboot the MOBOTIX camera (**Admin Menu > Reboot Camera**).

Once the camera has rebooted, make sure that the symbol **FR REC** is no longer visible in the bottom right-hand corner of the live image. You can now safely remove the MicroSD card from the camera (see *Section 2.2.9, «Replacing the MicroSD Card»*).

Caution

A **MicroSD card may only be removed from the camera after you have deactivated the recording** to MicroSD card and **rebooted the camera**. **Failing to do so may lead to data loss!**

Removing connected flash storage devices from the camera without properly deactivating them may lead to data loss and/or destroy certain sectors of the storage device. This is limited to 4 MB of lost data per incident due to MxFFS formatting.

3.5.6 Using a MicroSD Card in a Different MOBOTIX Camera

A MicroSD card containing recorded data from a MOBOTIX camera can be inserted into any MicroSD card-enabled MOBOTIX camera. Once MicroSD card recording has been activated (requires a reboot), the “new” MOBOTIX camera automatically synchronizes with the card and resumes recording. No data is lost in this process. Make sure that you deactivate MicroSD card recording before removing the card from a MOBOTIX camera and then reboot the camera.

If the MicroSD card’s contents are encrypted, you need to enter the same password in the “new” camera in the **Admin Menu > Storage on External File Server / Flash Device** dialog box. Otherwise, the camera cannot access the MicroSD card.

3.5.7 Limitations on Warranty When Using Flash Storage Media

MOBOTIX will not assume any responsibility for flash storage devices (for example, MicroSD cards or connected USB storage devices) delivered with or integrated into MOBOTIX cameras. The same applies to damage to flash storage devices or damage resulting from the use of devices that are not supplied by MOBOTIX.

3.6 Configuration in the Browser

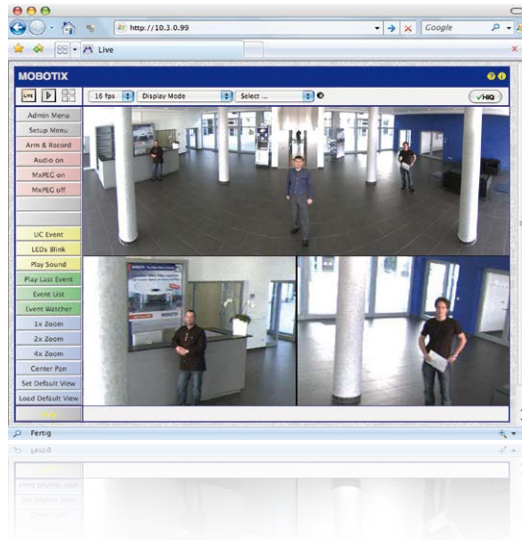

3.6.1 Overview

A MOBOTIX camera can be completely configured using a JavaScript-enabled browser on all common operating systems (such as Windows, Linux, Apple, etc.). The camera provides a HTML-based user interface for this purpose. The camera executes the changes you make to the camera configuration via HTTP commands using programs and scripts of the embedded software. The settings are stored in the camera's flash memory.

This section contains an overview of the basic browser settings of the MOBOTIX camera as well as further configuration options. Detailed information on the software functions is provided in the camera's online help.

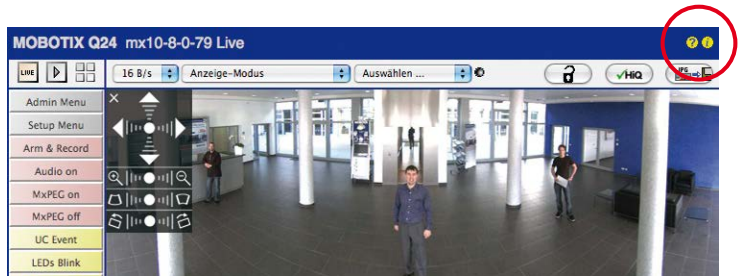

Basic Settings

- **Administering the camera:** You can modify the camera configuration in the Admin Menu or the Setup Menu.
 - **Admin Menu:** This menu contains the basic configuration dialog boxes of the camera (for example, passwords, interfaces, software updates).
 - **Setup Menu:** This menu contains the dialog boxes for configuring the image, event and recording parameters. Some of these settings can be changed using the corresponding Quick Controls in the live view.
- **Resetting changes:** If you would like to reset some larger changes in one dialog box without resetting the complete configuration, you can use the **Default** button at the bottom of the dialog box to reset only this dialog box's settings to the factory defaults. If you would like to reset all image settings, you can do so using the **Manage Settings > Restore Image Settings** Quick Control in the live image of the camera.
- **Storing changes permanently:** Once you have finished configuring the camera, you should always store the settings in the camera's permanent memory. You can do so in each dialog box (clicking on the **Set** button at the bottom of each dialog box will temporarily implement the change; when you click **Close**, you will be asked to store the complete configuration in the camera's permanent memory) or in the Admin Menu (**Admin Menu > Store current configuration into flash memory**). The **Configuration** section of the Admin Menu provides more functions for storing, copying and managing camera settings. For more information on this topic, refer to the online help for the specific dialog boxes.
- **Time tasks and time synchronization:** Apart from a multitude of possibilities for controlling the camera using time (time tables, holiday and vacation, scheduled tasks, etc.), the camera can also synchronize its internal clock. This allows you to manually synchronize the camera with a computer or automatically using a time server or another MOBOTIX camera. The camera can use either NTP time servers or Time Protocol servers. For more information on this topic, refer to the online help for the specific dialog boxes.
- **The "More" and "Less" buttons:** When opening some of the camera dialog boxes, the camera only shows the most important parameters. These dialog boxes have a **More** button in the bottom right-hand corner. Click it to display additional options. If all options are displayed, click on the **Less** button to hide the additional options.

User name: **admin**
password: **meinsm**

Admin Menu

Setup Menu

Make sure to permanently store changed parameters!

Automatic time synchronization using a time server

More: Display advanced features

Less: Hide advanced features

3.6.2 General Browser Settings

- **Run the Quick Installation:** After booting a new MOBOTIX camera, accessing the administration menu for the first time will automatically start the Quick Installation assistant (**Admin Menu** button). The Quick Installation assistant helps you in setting the most important parameters of the camera. For security reasons, you should set your own administrator password and disable public access to the camera.
- **Disable public access:** Guest users are only allowed to access the Guest screen of the camera without entering a password. If this is not required, you should deactivate public access (**Admin Menu > Quick Installation** or **Admin Menu > Users and Passwords**).
- **Add users and assign access rights:** Similar to a computer operating system, you can add users and user groups and assign the desired rights (**Admin Menu > Users and Passwords**, **Admin Menu > Group Access Control Lists (ACL)**). This approach allows individual access rights to be assigned or denied to camera-specific features based on the user groups.
- **Deactivate the automatic reboot:** In its factory state, every MOBOTIX camera will automatically reboot at 3:36 a.m. every day. All images in the camera's storage buffer will be deleted during this reboot. Images stored on external file servers, internal flash storage, or SD cards will NOT be affected by this reboot. Make sure that you deactivate the automatic reboot if this is not desired (**Admin Menu > Time Tasks**).
- **Optimize the image settings:** The factory image settings of MOBOTIX cameras deliver excellent images for most application scenarios and should therefore not be changed. If you do wish to make changes, your changes should be minor and gradual. You should, however, set an image program according to the application scenario of the camera. Image programs provide a quick and simple method for adjusting the camera to the application scenario as they perform several configuration steps at once (**Image Programs** Quick Control).
- **Set the resolution of the live image:** By default, all MOBOTIX cameras are factory-set to an image resolution of 640 x 480 pixels. You can select the desired resolution using the **Resolution** Quick Control.
- **Adjust the exposure:** The automatic exposure control of the MOBOTIX camera uses individually configurable exposure windows to determine the best image exposure. Open the **Exposure Control** Quick Control and select a predefined set of exposure windows. If required, you can also define custom exposure windows (**Setup Menu > Exposure Settings**).
- **Activate event control and recording:** By default, the MOBOTIX camera's event control is disabled. Click on the **Arm & Record** button to activate event control. This will activate motion detection and recording. Cameras with integrated flash memory (MOBOTIX R models and models with an SD card) will automatically use the flash memory to store image and video data (recording target). If desired, you can set additional events and adjust the settings of the recording and storage parameters (**Setup Menu > Event Settings**, **Setup Menu > Recording** and **Admin Menu > Recording to External File Server / Flash Device**).

- **Set up actions/messaging:** Upon detecting an event, the MOBOTIX camera can trigger alarms. These alarms can be adjusted to your needs and you can assign them to a specific event: playing back an alarm sound on the camera speaker, showing the visual alarm in the camera live image, sending an e-mail or network message with the alarm image, placing a phone call, uploading an alarm image to an FTP server, switching a signal output line of the camera (for example, for switching on the lights/opening a door).

For the settings, see **Setup Menu > Action Group Overview**. The actions to be performed are defined and used in these action groups in the form of “action profiles.” The different action profiles can also be defined in the following areas: Admin Menu in the Hardware Configuration (profiles for signal output), Transfer Profiles (FTP, e-mail, network messages) and Sound and VoIP Telephony (sound profiles, VoIP profiles). For more information, refer to the online help for the **Action Group Overview** dialog box.

- **Activate shock detector:** The S15 is also equipped with a shock detector as standard (for all IT and Secure models). If, for example, the camera’s housing receives a blow, it automatically registers it and sends a notification via a network message or telephone call. A general advantage is that MOBOTIX cameras are extremely tough because of the absence of mechanical moving parts. This allows them to stay fully operational when they are subject to strong vibrations. Open the **Setup Menu > Event Control > Environment Events > Edit** dialog box if you would like to activate the shock detector (and any other sensors).

3.6.3 Settings When Using Thermal Sensor Modules

Before you start using thermal sensor modules, you need to register them with the camera so you can access the settings that are specific to thermal image sensors.

- In the camera’s browser interface, click on the **Admin Menu** button and in the **Hardware Configuration** section, open the **Image Sensor Configuration** dialog.
- Use the dropdown fields (**Left Sensor**, **Right Sensor**) to select the camera ports (*External sensor Cam1*, *External sensor Cam2*) to which you will connect thermal image sensors.
- You can also use this section to select the sensor module (*External sensor Cam1*, *External sensor Cam2*) that will be shown at the left (**Left Sensor**) or at the right (**Right Sensor**) in the dual image.
- Close the dialog and save the configuration of the camera.

You can now configure the settings in the **Setup Menu > Thermal Sensor Settings** dialog to your requirements.

3.7 Special Case: Setting Up an S15 FlexMount as a Door Station

3.7.1 Installation

An S15 FlexMount can also be installed and configured as a hemispheric door station. Depending on how you want to configure the door station functionality, you have the choice of using different remote stations, bell modules and other accessories.

If you want to use a MOBOTIX S15 as door station, you should download the two manuals *IP Video Door Station System Manual Part 1* and *Part 2* (www.mobotix.com > **Support** > **Manuals** > **IP Video Door Station**), since these manuals contain additional information about using the camera as door station.

Required Accessories

- **MX-DoorMaster:** This MxBus module is always required if you intend to operate a door opener via the door station. In addition, the MX-DoorMaster provides the backup power supply for the entire door station using its automatically recharged battery (see www.mobotix.com > **Products** > **Cameras** > **IP Video Door Station** > **Functional Modules**).
- **Door bell:**
 - **BellRFID** bell button module with different button sets for the IP Video Door Station (one to five buttons, with or without function button), including transponder cards for keyless entry and operating the mailboxes. This module is connected to the MxBus interface of the S15 using a two-wire cable (cannot be used together with KeypadRFID).
 - **KeypadRFID** keypad module for the IP Video Door Station, which is using numeric codes or transponder cards for keyless entry and operating the mailboxes. This module is connected to the MxBus interface of the S15 using a two-wire cable (cannot be used together with BellRFID).
 - Up to two regular bell buttons connected to the signal inputs of an **MX-232-IO-Box**. The MX-232-IO-Box itself is connected to the MxBus interface of the S15 using a two-wire cable.
- **Remote station:**
 - Computer (Windows or Mac OS X) with **MxEasy**
 - iOS device (iPhone, iPad, iPad mini, iPod touch) with **MOBOTIX App**
 - **MxDisplay** (remote station with touch panel by MOBOTIX, available in the future)
 - **Grandstream** video phone

Optional Accessories

- **AudioMount** mounting adapter for the S15M with self-adhesive front and pre-installed microphone and speaker. Using this mounting adapter, you can easily attach a S15M to the back of a stainless steel plate or the inside of a letter box, for example (see *Section 1.4.14, «AudioMount»*).



Notes

- In order to be able to use an S15 as door station, please make sure that the camera is running software release 4 . 1 . 9 or higher.
- Only the new **MX-DoorMaster** (article no. **MX-Door2-INT-PW**) can be used together with the S15! The predecessor T24-DoorMaster (article no. MX-Door1-INT-PW) **cannot** be used with an S15.

For installing and wiring these components, follow the same steps as for the MOBOTIX IP Video Door Station. You can find detailed information about wiring as well as the maximum cable lengths in the *IP Video Door Station System Manual Part 1* and in the documents *BellRFID Quick Installation*, *KeypadRFID Quick Installation* and *MX-232-IO-Box Quick Installation* (www.mobotix.com > **Support** > **Manuals**).

3.7.2 Execute Auto Configuration

Just like with the IP Video Door Station, you can use the camera's **Auto Configuration** to set up the S15 as a door station without a computer. Once all required components have been wired and connected to the S15, you can launch the auto configuration to set up the S15 as a door station.

Starting the Auto Configuration

1. Remove the power supply of the camera, then restore the power supply. The camera will execute a reboot and the LEDs next to the camera keys are lighting up green and red.
2. Press both keys on the camera front (**R/L**) and keep them pressed until the LEDs are flashing several times. Release the keys.

Setting Up a KeypadRFID Module

With this module, the end of the auto configuration is signaled as follows – number keys are flashing white, the **ESC** key is flashing red and the **OK** key is flashing blue.

1. Enter the Super PIN you want to use and add an admin card.
2. Train the user cards as required.

You can find detailed information on setting up the KeypadRFID module in the *IP Video Door Station System Manual Part 2* in *Section 2.2*, «*Setting up the Keypad*».

Setting Up a BellRFID Module

With this module, the end of the auto configuration is signaled as follows – the blue and green status LEDs are flashing and the **OK** button is red.

1. Enter the Super PIN you want to use on the keypad insert and press **OK**. This button turns green and the letter button lights up red.
2. You can select the applicable bell button set by pressing any one of the button contacts in the center.

3. Once you have found the proper pattern, keep any one of the buttons at the center pressed until the LEDs are flashing repeatedly in a sequence. Next, the **OK** and letter buttons light up green and the **ESC** button lights up red.
4. Insert the function and bell buttons as required.
5. Train the admin card. All three LEDs are now green.
6. Train the user cards as required.

You can find detailed information on installing and operating the BellRFID module in the document *BellRFID Quick Installation* (www.mobotix.com > **Support** > **Manuals**).

Finalizing the Setup

The most important functions of the door station are now available. Even the mailbox has been pre-configured. You can make the remaining adjustments – just like with a “regular” IP Video Door Station – without a computer using a Grandstream video phone as remote station or with a computer using MxEasy or a web browser.

3.7.3 Setting Up an S15 as a Door Station

As an alternative to using the auto configuration of the camera as described in the last section, you can also use MxEasy to configure an S15 as a door station (just like when setting up an IP Video Door Station). Similar to the process above, all components need to have been wired and connected beforehand.

Note

This functionality is supported by MxEasy version 1 . 6 . 1 and higher. The camera needs to run on a software (firmware) version 4 . 1 . 9 or higher.

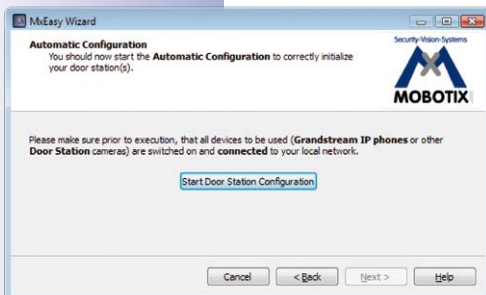

In this case, the MxEasy **Wizard** executes the auto configuration and guides you through the setup of the attached modules, the bell button profiles, etc. in a step-by-step manner.

For additional information on this topic, see the *MxEasy User Manual 1.6.1* in Section 2.3.3, «Special Case: Integrating an IP Video Door Station» (www.mobotix.com > **Support** > **Manuals** > **Software** > **MxEasy**).

3.8 Additional Notes

3.8.1 Do Not Sharply Bend the Connection Cables to the Sensor Modules

In order to ensure proper functioning of the sensor modules, you need to make sure that the connection cables to the sensor modules are not bent sharply.



3.8.2 Reduced Weather Protection When Installing Upside-Down

If you are installing the S15 upside-down (i.e., the connectors are pointing upwards), the camera does not reach protection class IP65 any more, but only IP54. If mounted upside-down, the camera can only be used in a dry indoor environment.



Connectors pointing down



Connectors pointing up

3.8.3 Password for the Admin Menu

Accessing the Admin Menu of the camera (**Admin Menu** softbutton) is only possible after entering a user name and password.

- Factory default user name is **admin**.
- Factory default password is **meinsm**.

The **Quick Installation** assistant automatically appears when the Admin Menu is accessed for the first time. It provides an easy method to adjust the basic camera settings to the current application scenario. For security reasons, we highly recommend changing the default administrator password after the camera has been properly configured.

Enter the user name and password exactly as shown above. Note that all entries are case-sensitive.

Caution

Make sure that you store information on **user names and passwords** in a secure place. If you lose the administrator password and cannot access the administration menu, the password can only be reset at the factory. This service is subject to a fee!

The microphone can be irreversibly deactivated!

3.8.4 Permanently Deactivating the Microphone

Deactivating a camera's microphone may be necessary in order to protect the privacy of persons at a workplace or for other reasons. You can permanently and irreversibly deactivate the microphone in the **Admin Menu > Loudspeaker and Microphone** dialog box.

Caution

This **deactivation occurs in the camera module itself and cannot be reversed**, even at the factory. Deactivating the microphone will also deactivate all functions that are making use of the microphone.

3.8.5 Starting the Camera with the Factory IP Address

If the camera's IP address is not known, you can start the camera with its factory IP address. This procedure is described in detail in *Section 3.2.6, «Starting the Camera with an Automatic IP Address (DHCP)»*.

3.8.6 Resetting the Camera to Factory Settings

All settings of the MOBOTIX camera can be reset permanently to the factory default settings. This makes sense if you have, for example, obtained a camera without any information or you would like to reset all settings after testing the camera. In order to perform this procedure, you need to have administrative access to the camera (`admins` group). Open **Admin Menu > Reset** to reset the camera to factory defaults.

Note

All defined users are deleted and the admin password is reset to the factory default when you reset the camera using **Admin Menu > Reset**. Use the method described in *Section 3.2.6, «Starting the Camera with an Automatic IP Address (DHCP)»* if you would like to maintain the existing users.

3.8.7 Activating Event Control and Motion Detection

In its default configuration, the camera's event control and video motion detection features are not enabled. In order to activate event-controlled recording, open **Setup Menu > General Event Settings** and activate the Arming switch. Another method is to click on the **Arm & Record** softbutton in the browser's user interface. The camera displays the motion detection window in the live image (dotted frame in the center) and the camera automatically stores images as soon as the motion detection window detects movements.



If the dotted rectangle in the live image is visible, the camera is armed

3.8.8 Deactivating Text and Logo Options

As camera arming is deactivated in the camera's default configuration (see preceding section), the MOBOTIX camera only displays the text `www.mobotix.com`, the time stamp and the MOBOTIX logo at the top of the image. Once the camera arming has been activated, the text at the bottom of the live image (event, action, messaging and recording symbols) will also appear.

You can deactivate the status bar at the bottom of the live image and the text bar in the top left-hand corner by setting Text Display in the **Setup Menu > Text & Display Settings** dialog box to **Off**. Setting Text Display to **Date and Time** will only display the time stamp in the live image. To hide the logo in the live image, open **Admin Menu > Logo Profiles** and set **Logo Display** to **Deactivated**.

3.8.9 Deactivating the Camera Reboot

By factory default, the MOBOTIX camera automatically reboots once a week between 3 a.m. and 4 a.m. The reason for this is that in some rare cases, external influences (for example, radiation at high altitudes) can sometimes lead to camera malfunctions. The automatic reboot will refresh the camera's memory and will ensure proper operation without requiring any interaction on the part of the user. If desired, you can deactivate the automatic reboot of the camera in the **Admin Menu > Time Tasks** dialog box.

3.8.10 Browser

Current Internet browsers (Internet Explorer, Mozilla Firefox, Safari, Google Chrome, Opera, etc.) with enabled JavaScript can display the camera's live images with their standard settings.

3.8.11 Cleaning the Camera and Lens

If the lens becomes dirty during the installation process, clean the lens using a lint-free cotton cloth. Make sure that the lens is still in focus after cleaning and adjust its focus if required.

Cleaning Domes, Lenses and Filters:

- Always mount and unmount the dome using the blue lens wrench (M.7) in order to protect it from being scratched and from getting dirty.
- Use the wide side of the black module wrench (M.8) for mounting/unmounting lens protection covers/filters. The slim side of the wrench is used to adjust the focal length (sharpness) of all lenses (except L10-L12).
- You should clean the dome at regular intervals. Always use a soft, lint-free cotton cloth for this purpose.
- If the dirt is more persistent, add a mild alcohol-free detergent without abrasive particles.
- Make sure you instruct cleaning personnel on how to clean the camera.

Text and logos can be also deactivated or individually configured



M.7



M.8

3.8.12 Legal Notes



Attention – Special Export Regulations Apply! Cameras with thermal image sensors (“thermal cameras”) are subject to the special export regulations of the U.S.A. and the ITAR (International Traffic in Arms Regulation):

- **According to the currently applicable export regulations of the U.S.A. and the ITAR, cameras with thermal image sensors or parts thereof must not be exported to countries embargoed by the U.S.A. or the ITAR. At present, this applies to the following countries: Syria, Iran, Cuba, North Korea and Sudan. The same export ban applies to all persons and institutions listed in “The Denied Persons List” (see www.bis.doc.gov > Policy Guidance > Lists of Parties of Concern).**
- **Under no circumstances can the camera itself or its thermal image sensors be used in the design, the development or in the production of nuclear, biological or chemical weapons or in the weapons themselves.**



Legal aspects of video and sound recording: You must comply with all data protection regulations for video and sound monitoring when using MOBOTIX products. Depending on national laws and the installation location of the S15, the recording of video and sound data may be subject to special documentation or it may be prohibited. All users of MOBOTIX products are therefore required to familiarize themselves with all valid regulations and comply with these laws. MOBOTIX AG is not liable for any illegal use of its products.

3.8.13 Safety Warnings



Installation Instructions:

- This product must not be used in locations exposed to the dangers of explosion.
- Make sure to install this product as shown in *Chapter 2, «Installation»* of this manual.
- When installing this product, make sure that you are only using genuine MOBOTIX parts and MOBOTIX connection cables.
- Make sure that you are installing this product on a solid surface that provides for a sturdy installation of the fixing elements used.



Electrical installation: Electrical systems and equipment may only be installed, modified and maintained by a qualified electrician or under the direction and supervision of a qualified electrician in accordance with the applicable electrical guidelines. Make sure to properly set up all electrical connections.



Electrical surges: MOBOTIX cameras are protected against the effects of small electrical surges by numerous measures. These measures, however, cannot prevent the camera from being damaged when stronger electrical surges occur. Special care should be taken when installing the camera outside of buildings to ensure proper protection against **lightning**, since this also protects the building and the whole network infrastructure.



Max. power consumption of attached extension modules: The power consumption of all attached *MxBus modules* must **not exceed 3 W**. When attaching modules to the MxBus connector **and** the USB connector, the **power consumption of all attached modules must not exceed 4 W, if the camera is powered by PoE class 3**. If **PoE class 2** is

Additional Notes



used, **the power consumption of all attached modules must not exceed 1 W!** If thermal sensor modules are used with this camera, **PoE Class 3 is required** and **the power consumption of all attached modules (MxBus and USB) must not exceed 1 W.**

Never touch the dome or the protective lens covers: Due to the high performance of the S15, the area of the image sensor **can get quite hot**, especially when the ambient temperature is also high. This does not affect the proper functioning of the camera in any way. For this reason, the product must not be installed within the reach of persons without domes or protective lens covers.

Only exchange sensor modules when powered off: Make sure that the camera's power supply has been disconnected before attempting to exchange any sensor modules.

Network security: MOBOTIX products include all of the necessary configuration options for operation in Ethernet networks in compliance with data protection laws. The operator is responsible for the data protection concept across the entire system. The basic settings required to prevent misuse can be configured in the software and are password-protected. This prevents unauthorized parties from accessing these settings.

3.8.14 Online Help in the Browser

For more information, see the News and Functional Overview pages in the online help of the camera's browser interface. Click on the  icon to open the camera's online help. Furthermore, detailed information on the camera and its current configuration is displayed in the **Camera Status** dialog box when you click on the  icon.

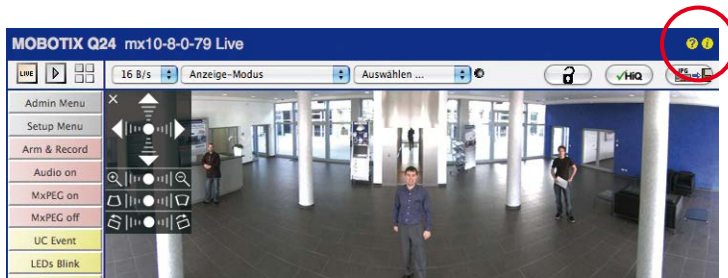

3.8.15 RoHS Declaration

The products of MOBOTIX AG are in full compliance with Art. 5 of the German Electrical and Electronic Equipment Act and the E.U. Directive 2002/95/EC on the Restriction of the Use of Certain Hazardous Substances in Electrical and Electronic Equipment (RoHS) as far as they are subject to these regulations. (You can find the MOBOTIX RoHS Declaration under www.mobotix.com, **Support > Spec Sheets**).

3.8.16 Disposal

Electrical and electronic products contain many reusable materials. For this reason, we would ask that you dispose of MOBOTIX products at the end of their service life in accor-

© MOBOTIX AG • Security-Vision-Systems • Made in Germany

www.mobotix.com • sales@mobotix.com



dance with all legal requirements and regulations (or deposit these products at a municipal collection center). MOBOTIX products may not be disposed of with household waste! If the product contains a battery, please dispose of the battery separately (the corresponding product manuals contain specific directions if the product contains a battery).

3.8.17 Disclaimer

MOBOTIX AG does not assume any liability for damage that is the result of improper use of its products or failure to comply with the operating manuals or the applicable rules and regulations. Our **General Terms and Conditions** apply. You can download the current version at www.mobotix.com (using the cos link at the bottom of each page).





To demonstrate our confidence in the quality of our products, MObOTIX cameras have been used to capture all images that appear in this manual.

Manufacturer

MObOTIX AG
Kaiserstrasse
67722 Langmeil
Germany

Phone: +49 6302 9816-103

Fax: +49 6302 9816-190

www.mobotix.com

sales@mobotix.com

Registration Office: Kaiserslautern Local Court

Registration Number: HRB 3724

Tax Office: Worms-Kirchheimbolanden, Germany

Tax Code: 44/676/0700/4

VAT ID: DE202203501

You can find the latest version of this and other documents (e.g., declarations of conformity) at www.mobotix.com in the **Support** section.



Technical specifications subject to change without notice!



Discreet. Flexible. Hemispheric.

With the S15D FlexMount, one or two sensor modules (6MP/5MP, Day/Night/Night-LPF/Thermal) are connected to a concealed camera housing via cables up to 3 m/9.8 ft long. Two adjacent rooms can be discreetly monitored with only one camera.



Innovations – Made in Germany

The German company MOBOTIX AG is known as the leading pioneer in network camera technology and its decentralized concept has made high-resolution video systems cost efficient.

MOBOTIX AG • D-67722 Langmeil • Phone: +49 6302 9816-103 • Fax: +49 6302 9816-190 • sales@mobotix.com

6MP
Sensor

MxLEO

360°

50 mK

VPTZ

MxBus

USB

+60°
-30°

IP65
