

MOBOTIX M25M AllroundMono Camera



More Camera For Less. Guaranteed!

The M25M family comprises compact, cost-efficient and extremely powerful allround cameras featuring 5MP sensor technology and a vast choice of lenses including hemispheric models. Fully equipped with IP66-certified housing and long-term internal storage on a MicroSD card.

- Freely configurable lens: Telephoto/wide-angle lens, day/night, CSVario and hemispheric (180°)
- Latest MOBOTIX 5MP image sensor technology delivers excellent image quality
- Fast and simple installation on walls, poles or ceilings
- Integrated DVR (up to 64 GB) for HiRes video recording without affecting the network load
- Sturdy, low-maintenance and weatherproof from -30 to +50 °C (-22 to +122 °F) (IP 66)
- Digital, continuous panning, tilting, zooming
- Microphone, speaker and intelligent movement sensors (MxActivitySensor)

MOBOTIX Advantages

Extremely high-sensitive 5-megapixel sensors • All relevant events are automatically saved • Highly secure as motion sensors detect even the smallest movements and reduce the number of false alarms • Cost-effective as fewer cameras are needed thanks to HiRes Images • Maintenance-free with no heaters, fans or moving parts • Can be expanded thanks to encrypted two-wire bus (MxBus) • Synchronization via GPS satellite means data available in real time • Weatherproof from -30°C to 50°C (-22°F to 122°F) • No licensing or software fees, free-of-charge updates



Camera Housing	
	Standard housing <ul style="list-style-type: none"> AllroundMono system with individual choice of lens Incl. FlexMount wall and ceiling mount Simple installation and concealed cabling

Accessories	
	Pole mount <ul style="list-style-type: none"> 3 mm powder-coated stainless steel 2 stainless steel straps for pole diameters from 6 to 18 cm, incl. mounting parts

	PoE injector <ul style="list-style-type: none"> Power supply via power grid and battery (12 to 42 V) For direct PC connection without a switch thanks to integrated crossover function
---	---

	Mx2wire+ media converter <ul style="list-style-type: none"> Ethernet with PoE using two-wire cable Suitable for coaxial cables, bell wires, power cables and more
---	--

	ExtIO function expansion <ul style="list-style-type: none"> Microphone/Speaker Infrared motion sensor, temperature sensor 2 signal inputs, 2 signal outputs, 2 illuminated keys
---	---

Frost-Proof Without Extra Heater

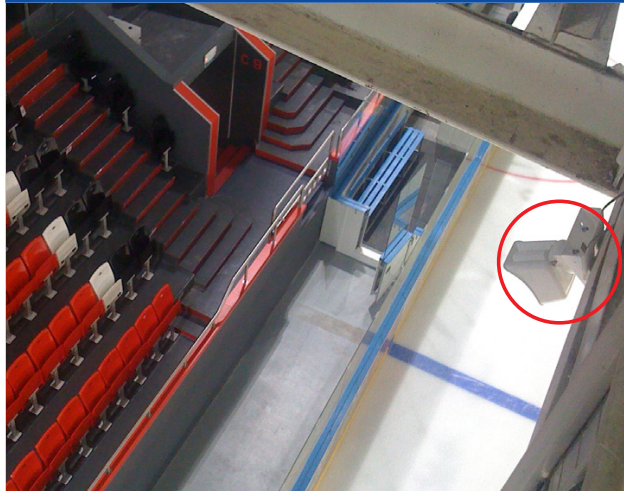

In the ice stadium: The 5MP color sensor delivers useful images even when illumination is at a minimum after closing time, and the super-robust, weatherproof MOBOTIX camera (IP66) even withstands extreme temperature fluctuations.

Technical Data	
Model versions	IT, IT-Night, Sec, Sec-Night, Sec-D12, Sec-Night-N12, Sec-CSVario, Sec-Night-CSVario, Sec-D320, Sec-Night-N320, Sec-Night-N160-LPF
Lens options	12 to 320 mm format, horizontal angle 180° to 7°
Sensitivity	Color sensor: 0.25 lux at 1/60 s, 0.013 lux at 1 s B/W sensor: 0.05 lux at 1/60 s, 0.0025 lux at 1 s MxLEO – Lowlight Exposure Optimization
Image sensors	1/2.5" CMOS, 5 megapixels, progressive scan
Max. image size	Color: 2048 x 1536 (QXGA), B/W: 2048 x 1536 (QXGA)
Image Formats	2048 x 1536, 1280 x 960, 1024 x 768, 800 x 600, 768 x 576 (D1), 704 x 576 (TV-PAL), 640 x 480, 384 x 288, 352 x 288, 320 x 240, 160 x 120; free image format selection (e.g. 1000 x 200 for skyline)
Max. frame rate, M-JPEG (live/recording)	VGA: 30 fps, MEGA/HD: 10 fps, QXGA: 4 fps
Max. video rate MxPEG (live/recording/sound)	VGA: 30 fps, MEGA/HD: 30 fps, QXGA: 20 fps
Image compression	MxPEG, M-JPEG, JPEG, H.264 (SIP video only)
Internal DVR	MicroSD Slot (recording inside the camera, up to 64 GB; 4-GB card preinstalled)
External storage	Directly on NAS and computer/server without additional recording software
Software (free of charge)	MxEasy video management software, MxControlCenter control center software, MOBOTIX App for iOS devices iOS 5.0 and higher
Image processing	Backlight compensation, automatic white balance, image distortion correction (including panorama image correction), motion detection, MxActivitySensor
Virtual PTZ (vPTZ)	Digital pan/tilt/zoom, continuous 8x zoom, full image recording in the background
Alarm/events	Triggering of events by integrated multiple-window motion detection, external signals, temperature sensor, notification via e-mail, FTP, IP telephony (VoIP, SIP), visual/acoustic alarm, pre- and post-alarm images
Audio	Integrated microphone and speaker, lip-synchronous audio, intercom, audio recording
Interfaces	Ethernet 10/100, IPv4/IPv6, MiniUSB, MxBus; IO and RS232 via MX-232-IO-Box (accessory)
Video telephony	VoIP/SIP, intercom, remote controlling with key code, event notification
Security	User/group management, HTTPS/SSL, IP address filter, IEEE 802.1x, intrusion detection, digital image signature
Certifications	EMC (EN55022, EN55024, EN61000-6-2, FCC part 15B, AS/NZS3548)
Power supply	Power over Ethernet (PoE in accordance with IEEE802.3af): PoE class variable (2/3) depending on operating mode; power consumption: typ. 4.5 watts
Operating conditions	IP66 (DIN EN 60529), -30 to +50 °C/-22 to +122 °F
Dimensions	W x D x H: 14 x 23 x 19 cm
Weight	about 750 g

For more information on the entire range of MOBOTIX accessories and additional information on the M25M, such as prices, manuals, video management software for computers and iOS devices, etc., please go to www.mobotix.com > **Products**. Or - if you would like to talk to us on the phone to get advice with our products, please call +49 06302 9816-103.



Camera Model	M25M-IT	M25M-IT-Night	M25M-Sec	M25M-Sec-Night
Lenses, Sensors				
Hemispheric 12 mm (180° x 160°)	–	–	L12	L12
Super Wide-Angle 25 mm (82° x 61°)	L25	L25	L25	L25
Wide-Angle 38 mm (55° x 41°)	L38	L38	L38	L38
Wide-Angle 51 mm (40° x 30°)	L51	L51	L51	L51
Tele 76 mm (27° x 20°)	L76	L76	L76	L76
Tele 160 mm (13° x 10°)/with Long Pass Filter	L160/–	L160/–	L160/–	L160/L160-LPF
Tele 320 mm (7° x 5°)	–	–	L320	L320
CSVario 28 – 63 mm (28° – 58°)	–	–	CSVario	CSVario
Image sensor with individual exposure zones	Color	B/W	Color	B/W
Sensor sensitivity in lux at 1/60 s /1 s	0,25/0,013	0,005/0,0025	0,25/0,013	0,005/0,0025
Image sensor resolution (color or B/W sensor)	5 MP (2592 x 1944)	5 MP (2592 x 1944)	5 MP (2592 x 1944)	5 MP (2592 x 1944)

Hardware Functions				
Protection class	IP66	IP66	IP66	IP66
Temperature range -30 to +50°C/-22 to +122°F	•	•	•	•
Temporary internal DVR	32 MB	32 MB	64 MB	64 MB
Internal DVR, ex works (max. 64 GB)	4 GB (MicroSD)	4 GB (MicroSD)	4 GB (MicroSD)	4 GB (MicroSD)
Microphone/speaker	•/•	•/•	•/•	•/•
Passive infrared sensor (PIR)	–	–	–	–
Integrated temperature sensor	•	•	•	•
Shock detector	•	•	•	•
Power consumption (typical)	< 4,5 watts	< 4,5 watts	< 4,5 watts	< 4,5 watts
Variable PoE class (factory default: 3)	2 or 3	2 or 3	2 or 3	2 or 3

Image Formats, Frame Rates, Image Storage				
Maximum image format (per sensor)	HD (1280 x 720)	HD (1280 x 720)	QXGA (2048 x 1536)	QXGA (2048 x 1536)
Maximum frame rate (MxPEG, max. resolution)	30 fps (HD)	30 fps (HD)	20 fps (QXGA)	20 fps (QXGA)
CIF images with 4 GB MicroSD DVR	250,000	250,000	250,000	250,000
VGA images with 4 GB MicroSD DVR	125,000	125,000	125,000	125,000
HD images with 4 GB MicroSD DVR	40,000	40,000	40,000	40,000
QXGA images with 4 GB MicroSD DVR	–	–	20,000	20,000

- available ex works
- not available



Camera Model	M25M-IT	M25M-IT-Night	M25M-Sec	M25M-Sec-Night
General Functions				
Digital zoom (continuous) with panning	•	•	•	•
Codecs: Motion-JPEG/MxPEG/H.264 for SIP	•/•/•	•/•/•	•/•/•	•/•/•
Programmable exposure zones	•	•	•	•
Snapshot recording (pre/post-alarm images)	10	10	50	50
Terabyte ring buffer storage (internal/network)	•	•	•	•
Continuous recording with sound (0.2 to 30 fps)	•	•	•	•
Event recording with sound	•	•	•	•
Time and event control/flexible event logic	•/-	•/-	•/•	•/•
Weekly schedules/holidays	•	•	•	•
Web functionality (FTP, email)	•	•	•	•
Playback/QuadView and MultiView	•/•	•/•	•/•	•/•
Bidirectional sound in browser	•	•	•	•
Logo generator, animated	•	•	•	•
Master/Slave arming	-	-	•	•
Several scheduled privacy zones	-	-	•	•
Customized voice messages	•	•	•	•
VoIP telephony (audio/video, alert)	•	•	•	•
Remote alarm notification (network message)	•	•	•	•
Signal inputs/outputs and RS232 via	MX-232-IO-Box	MX-232-IO-Box	MX-232-IO-Box	MX-232-IO-Box
Programming interface (HTTP API)	•	•	•	•
Security Features (HTTPS/SL, IP-based access control, IEEE 802.1X network authentication)	•	•	•	•

Video Analysis				
Video motion detector	•	•	•	•
MxAnalytics	-	-	-	-
MxActivitySensor	-	-	•	•

Video Management Software				
MxEasy (Windows/Mac OS X)	•	•	•	•
MxControlCenter (Windows)	•	•	•	•
MOBOTIX App (iOS)	•	•	•	•



Delivered Parts M25M (Secure)



(Excerpt from the technical documentation: www.mobotix.com > Support > Manuals)

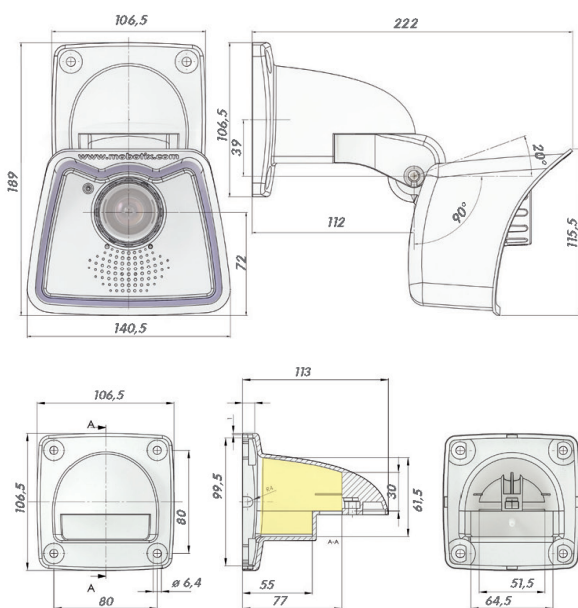

(Excerpt from technical drawings and 3D views: www.mobotix.com > Support > Image Database)



Wall mount

Lens unit

Lens unit

R key

L key

Loudspeaker

LEDs (1 x green, 1 x red)



Network connection

Mini USB

Bayonet catch

*Slot for MicroSD card
(not externally accessible)*

MxBus



(M25M – Camera housing and connectors, excerpt from the technical documentation)